

# SCOTT®

SABRE AIRLINE BREATHING APPARATUS



**SCOTT®**  
HEALTH & SAFETY

# SCOTT®

## AIRLINE BREATHING APPARATUS

*Airline breathing apparatus is the perfect solution for applications across many industries. However, the selection of the equipment has traditionally been seen as a complicated process – due to the high number of options available.*

*Aiding this selection process, Scott Health & Safety has over 65 years experience in the manufacture of breathing apparatus, providing unrivalled technical support and advice. With the widest choice of airline breathing solutions, the Company's Sabre range is internationally renowned for reliability, ease of use, durability and comfort.*

Ideal for environments where ambient oxygen cannot be guaranteed, airline breathing apparatus combines the highest degree of respiratory protection with long duration use. Fed by a medium pressure air hose, it is used for industrial applications as diverse as entering sewers, cleaning out tanks and spray painting military aircraft. The advantages are clear: there is no weight, no bulk and – in theory – an infinite amount of air.

Completely modular, Sabre airline components afford almost unlimited flexibility, allowing the user to individually specify a system that exactly meets their operational needs. Multiple configurations can be selected from a standalone portable product – for use where no other supply of compressed air is available – to products that integrate into existing compressor-fed airline infrastructure.





# WHAT TO CONSIDER WHEN SPECIFYING

*Before specifying airline breathing apparatus, it is vital that the intended work site is subject to a thorough risk assessment and that the required equipment advised by that assessment are in place before undertaking the task.*

*Areas to consider include:*

- **PRIMARY AIR SOURCE**

*This can be a factory airline, a compressor or compressed air cylinders. If a factory airline or compressor is to be used, is the air supply clean?*

An AFU will only remove water, particulates and oil mist. If there is any possibility of Carbon Monoxide or Carbon Dioxide in the air supply, then an air purifier will need to be used or an alternative clean air supply found.

- **SUPPLY PRESSURE WARNING DEVICES**

*How will the wearer know if there is a drop in medium pressure supply?*

Inline warning whistles give an audible warning, whereas a DS4 (automatic distress signal unit) provides both audible and visual alarms.

- **RESERVE AIR SUPPLIES**

*Do you need to provide an alternative supply of air?*

In addition to being standalone supply systems, the Sabre Modulair trolley system can be used as a back-up system, should a compressor supply fail.

- **CONNECTING UP THE SYSTEM**

*How are you going to connect the users to their air supply?*

Sabre have a range of hose types and lengths and CEN approved couplings to meet your operational requirements.

- **CHOOSING THE RIGHT AIRLINE BREATHING APPARATUS FOR THE JOB IN HAND**

*Will the wearer always work from the same airline supply line?*

*Will mobility between lines be required?*

*Is the wearer working in a confined space?*

Depending upon the answers to these questions, the Sabre Flite or RAS provide effective solutions to these important considerations.





# Modulair

The Sabre Modulair is a compact, easy to use airline trolley system designed to provide portable clean air in restricted access areas.

Versatile and robust, it consists of a lightweight stainless steel hose reel unit and cylinder frame that can be used independently or together. The frame is designed to carry a pair of cylinders and, where required, an additional frame can be vertically stacked to allow connection of up to four cylinders. This, in conjunction with proven 300 bar high performance pneumatics delivering up to 1000 litres of breathing air per minute, permits four people to work at the same time.

Long duration operation is made simple through adjustable cylinder bands and high pressure cylinder connectors to accommodate a variety of cylinder sizes at both 200 and 300 bar. Non-return bleed valves fitted to the cylinder connectors enable cylinders to be replaced independently for continuous operation.

To safeguard against any drop in air supply pressure the Modulair can be fitted with a medium pressure warning whistle or a DS4 (automatic distress signal unit) for both audible and visual alarms if the airline supply pressure falls below 3.8-4.1 bar (55-60 psi). In either case, the operation of the alarm informs safety rescue personnel to switch over to the reserve air supply, change cylinders or initiate evacuation procedures as appropriate.



- Robust and reliable, stainless steel construction
- 2 or 4 man operation
- 2 or 4 cylinder capability
- High performance pneumatics

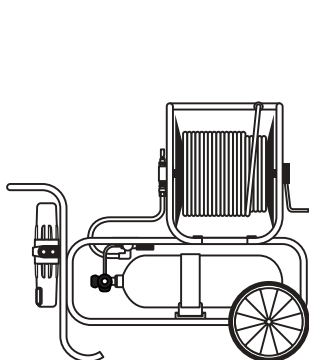

M-FRM-2-2-HRT-AFU

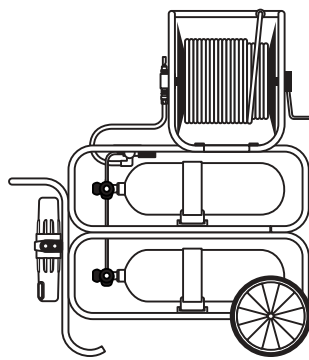

M-FRM-4-2-HRT-AFU



# Flite

Flite, in its simplest form, provides the user with breathing air from a medium pressure airline. It consists of a lightweight, easy to don bandolier harness with padded shoulder strap, a pigtail connection with safety locking coupling, a Tempest positive pressure demand valve with first breath activation and hands-free bypass facility.

As the equipment is positive pressure, it provides the user with the highest possible protection factor allowing Flite to be used in IDLH and oxygen deficient environments.

Flite apparatus can be used with any of the Sabre range of positive pressure facemasks: Vision 3, or Promask Postive Pressure.

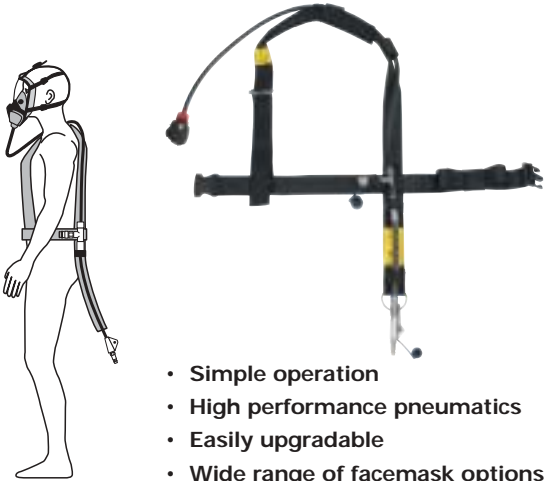

- Simple operation
- High performance pneumatics
- Easily upgradable
- Wide range of facemask options

# Flite Escape

With airline breathing apparatus the user's safety is dependent upon outside influences – the airline supply could become disrupted. Flite includes the option of an escape cylinder that can be added to the unit at any time, this serves as an important additional safety benefit to safeguard against a failure of the airline supply.

Flite Escape is widely used by people working in confined spaces or hazardous environments, such as the oil and gas industry, where levels of H<sub>2</sub>S can be extremely high.

10 and 15 minute steel cylinders or a 13 minute super-light carbon composite cylinder are available.

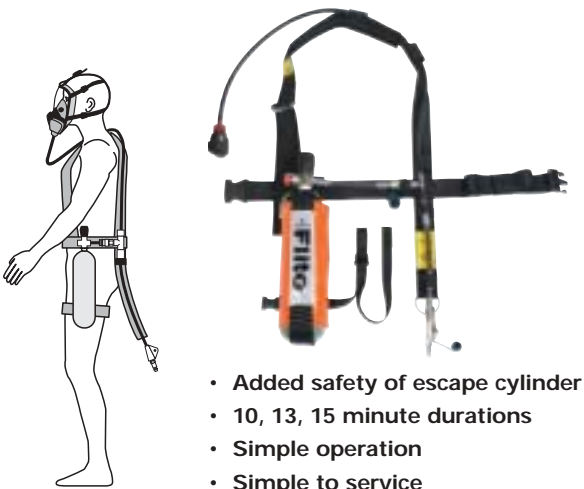

- Added safety of escape cylinder
- 10, 13, 15 minute durations
- Simple operation
- Simple to service





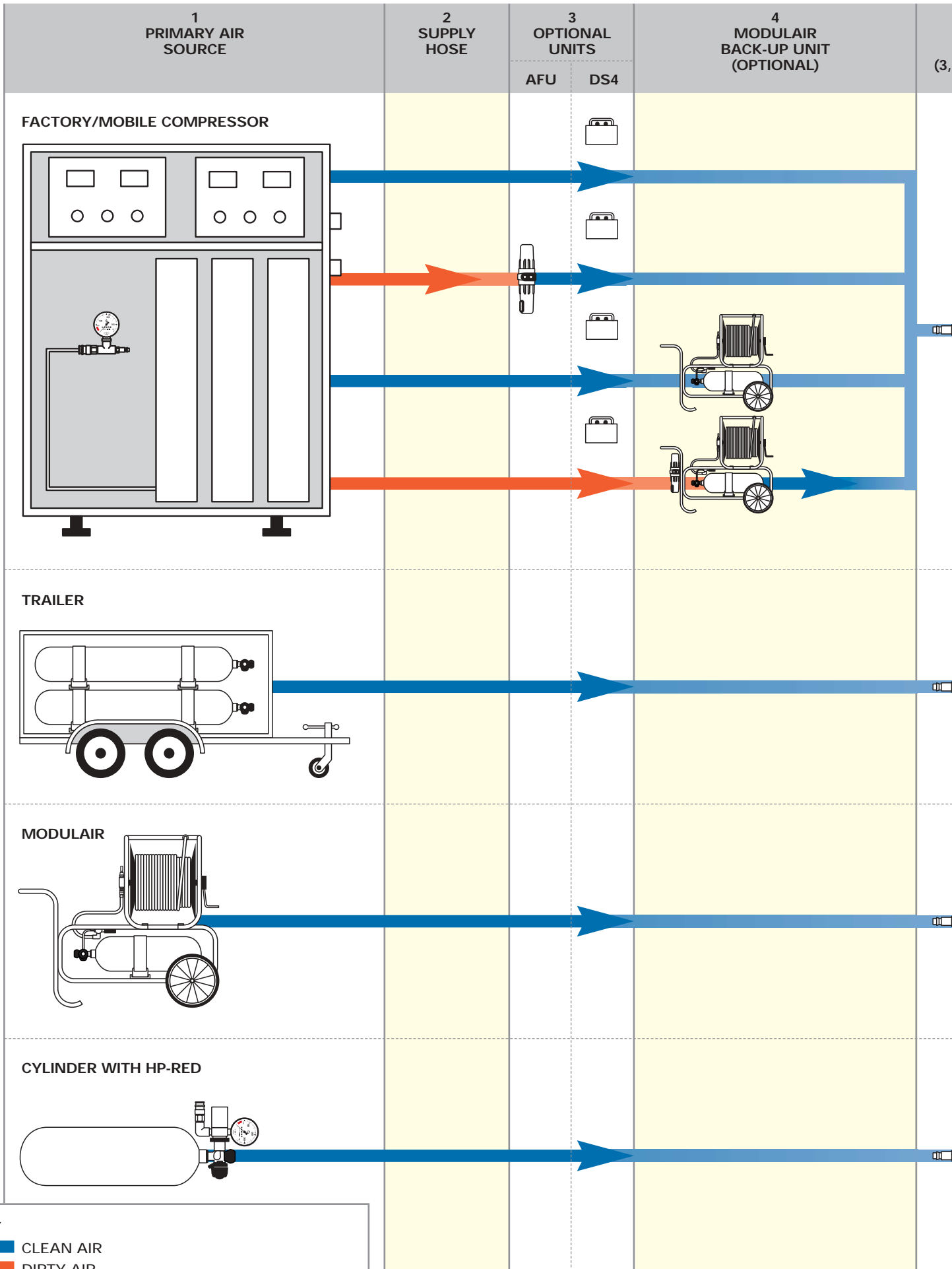

# Airline breathing apparatus - How to build a system



**KEY**

-  CLEAN AIR
-  DIRTY AIR
-  CLEAN AIR - Bypassing solo user operation

THESE EXAMPLES ARE DESIGNED TO GIVE AN INDICATION OF HOW AN AIRLINE SYSTEM CAN BE CONFIGURED. THESE ARE REPRESENTATIONS OF SABRE AIRLINE EQUIPMENT AND SHOULD NOT BE CONSIDERED AS FINAL. PLEASE SEE MODULAIR 2 MANUAL FOR APPROVED CONFIGURATIONS.

← MULTIPLE USER OPERATION →

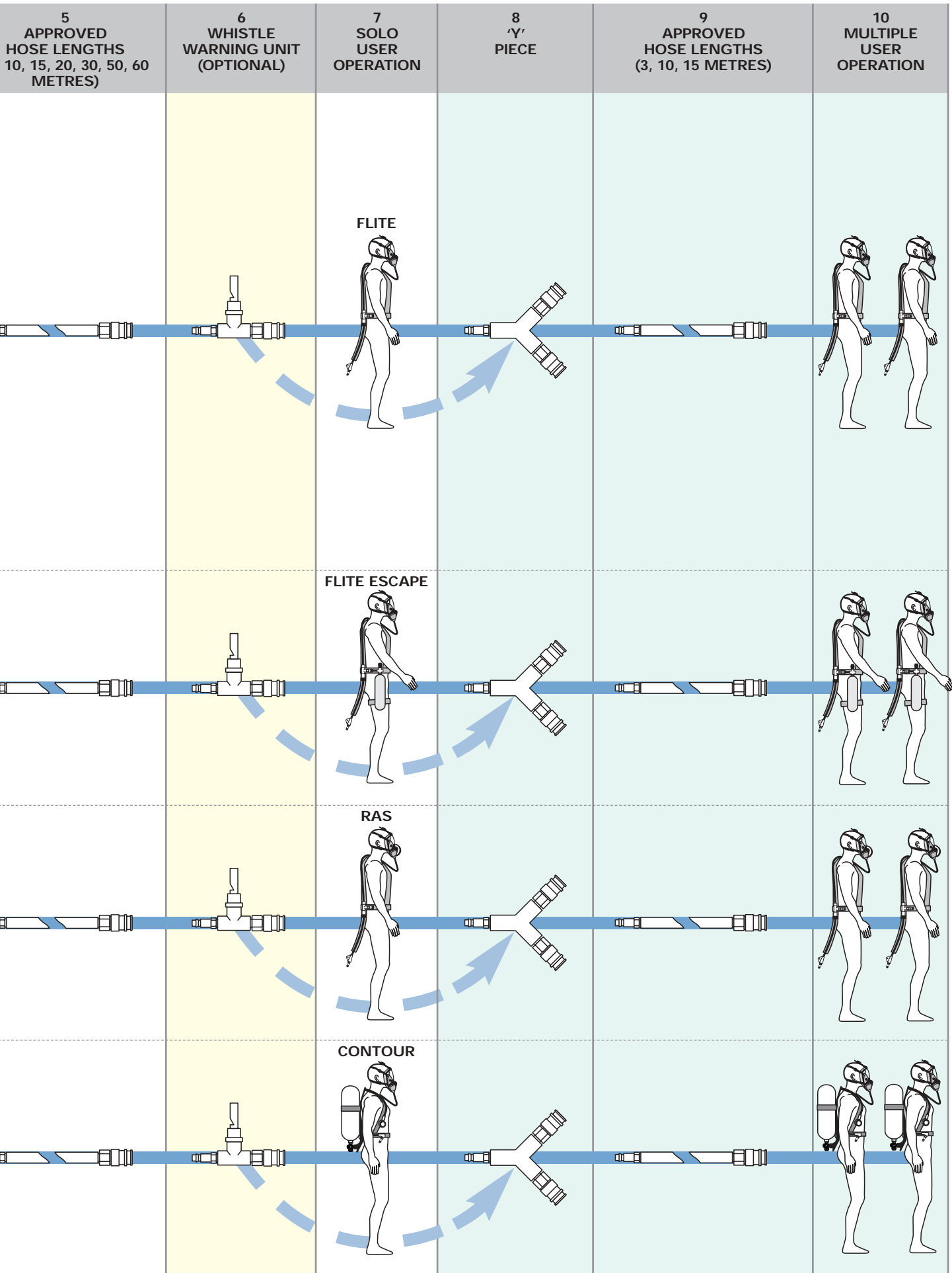

SYSTEM CAN BE BUILT UP. PLEASE NOTE THAT MANY OTHER CONFIGURATIONS CAN BE SPECIFIED. NB: THE LINE DRAWINGS ABOVE ARE ONLY FOR REFERENCE. MAXIMUM LENGTH OF HOSE TO THE USER AFTER THE MODULAIR SHOULD BE NO MORE THAN 105 METRES.

# RAS

With main application in paint spraying and asbestos stripping the Respiratory Airline System (RAS) is a novel solution to situations where the user must enter and egress from working environments where the hazardous atmospheres are known and the infrastructure of the airline network are semi permanent.

The RAS is a positive pressure system consisting of a Flite apparatus coupled with a facemask that has both positive pressure and DIN 40mm thread filter connections.

This solution increases freedom of movement by enabling the user to enter and egress from the working environment using a filter where there is no danger of there being an oxygen deficient atmosphere. Then, when in a working situation where the level of contaminants will be highest, connect into an airline system and work under positive pressure.

RAS versions of the Promask Positive Pressure and Vision 3 facemasks are available.

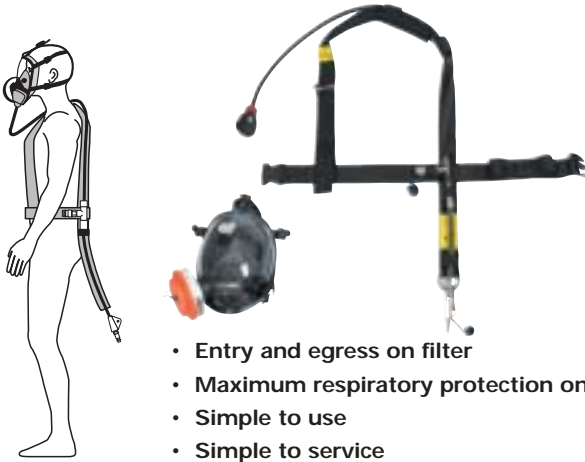

- Entry and egress on filter
- Maximum respiratory protection on DV
- Simple to use
- Simple to service

# RAS Asbestos

The RAS Asbestos is an industry specific product based upon the normal RAS system.

Used in exactly the same way, the RAS Asbestos has the added benefit of an in-line filter in the medium pressure supply hose. This filter removes particulates down to 0.5 microns and protects the wearer from any asbestos particles that may have entered into the pigtail during the entry and connection to the airline procedure.

The webbing bandolier is also made of a smoother material to aid with decontamination after use.



- Entry and egress on filter
- Added safety of in-line filter
- Maximum respiratory protection on DV
- Simple to service





# AIRLINE Accessories



**Y piece (021.042.00)**

The Y piece adds flexibility by splitting a single hose into two hoses. This allows two users to share a single air supply.



**Medium pressure inline whistle (035.146.00)**

When placed in the airline system between the breathing hose and the user this device provides a safe, clear warning should the airline pressure drop below 4 bar.

**Airline Filter Unit (AFU) (AFU-13-STA or AFU-25-STA)**

Available in two or four user versions, the AFU removes particles, oil and water from medium pressure compressed air making it suitable for use with breathing apparatus.



**Distress Signal Unit (DS4)**

The DS4 is an automatic distress signal unit for use with the Sabre Modulair. Indicating if action is urgently required, the DS4 monitors the medium pressure of an external air input, giving off a loud audible and visual alarm should there be a drop in air pressure.



**SCBA airline attachment (039.273.99)**

This attachment is fitted on to Sabre self contained breathing apparatus enabling them to be used with an airline system. This attachment is available on both the Cen-paq and Contour and existing sets can be easily upgraded if required.



**Medium pressure test gauge (035.147.02)**

Allows the user to check the pressure of the airline at the point of use.

**HP-RED2 (see overleaf for part nos)**

Reduces high pressure air from a single cylinder to medium pressure. As standard the HP-RED2 has a high pressure gauge fitted to display cylinder content. A 55 bar whistle is available together with a selection of connections to fit different types of cylinders.



## Hoses

PVC or AS	3, 10, 15, 20, 30, 50, 60 metres
-----------	----------------------------------

Hoses are available in both PVC and antistatic rubber materials in seven standard lengths. All airline hose connections are CEN safety couplings that are quick and easy to connect yet prevent accidental disconnection.



**Retractable hose reel (AHR-15M-PVC or AHR-15M-AS)**

Provides a means of convenient storage for 15 meters of hose. It is designed to maintain a safe work area by allowing the user to control the amount of hose laid out. Supplied with PVC or anti-static hose and wall mounting bracket.

# How to order a Modulair

## MODULAIR CONFIGURATIONS

BASIC UNIT: M-FRM-X-Y    X = NO. OF CYLINDERS    Y = NO. OF WEARERS (2 OR 4)

2 cylinders / max 2 users

2 cylinders / max 4 users

4 cylinders / max 2 users

4 cylinders / max 4 users

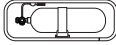
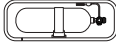
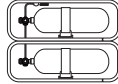
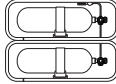
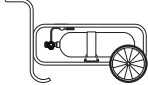
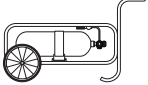
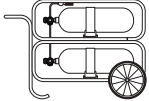
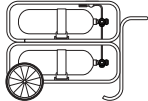
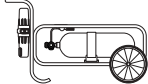
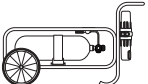
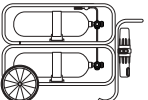
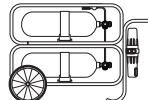
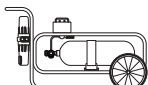
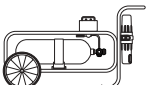
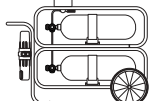
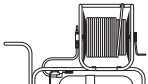
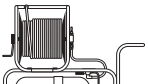
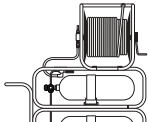
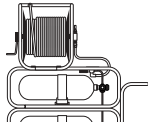
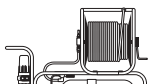
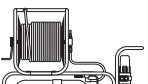
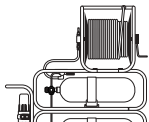
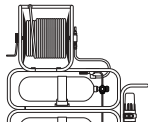
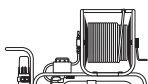
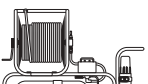
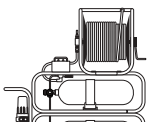
Frame and cylinder unit only					
FRAME	 M-FRM-2-2	 M-FRM-2-4	 M-FRM-4-2	FRAME	
	 M-FRM-4-4	<b>Mobile trolley conversion = frame fitted with handles and wheels</b>			
TROLLEY	 M-FRM-2-2-T	 M-FRM-2-4-T	 M-FRM-4-2-T	TROLLEY	
	 M-FRM-4-4-T	<b>Mobile trolley conversion with additional AFU &amp; MP whistle</b>			
	 M-FRM-2-2-T-AFU	 M-FRM-2-4-T-AFU	 M-FRM-4-2-T-AFU		 M-FRM-4-4-T-AFU
	 M-FRM-2-2-T-AFU-DS4	 M-FRM-2-4-T-AFU-DS4	 M-FRM-4-2-T-AFU-DS4		
<b>Hose reel trolley assembly – frame fitted with handles and wheels</b>					
HOSE REEL TROLLEY	 M-FRM-2-2-HRT	 M-FRM-2-4-HRT	 M-FRM-4-2-HRT	HOSE REEL TROLLEY	
	 M-FRM-4-4-HRT	<b>Hose reel trolley assembly – with additional AFU &amp; MP whistle</b>			
	 M-FRM-2-2-HRT-AFU	 M-FRM-2-4-HRT-AFU	 M-FRM-4-2-HRT-AFU		 M-FRM-4-4-HRT-AFU
	 M-FRM-2-2-HRT-AFU-DS4	 M-FRM-2-4-HRT-AFU-DS4	 M-FRM-4-2-HRT-AFU-DS4		

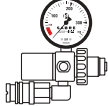
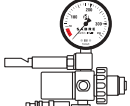
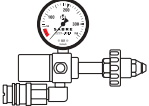
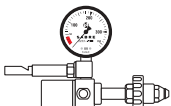
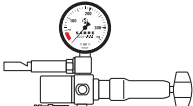
CEN COUPLINGS
 HP-RED2-C
 HP-RED2-W-C
 HP-RED2-B-C
 HP-RED2-B-W-C
 HP-RED2-P-W-C

C = CEN coupling  
 R = Bullnose coupling  
 W = Whistle  
 P = Pin index

NB – An AFU is required when you need to connect an airline and purify the air.  
 A DS4 is required for both audible and visual distress signals should the airline supply pressure drop.

The above configurations are designed to simplify the order process. Note the above do not include cylinders, hoses or airline connectivity devices such as 'y' pieces which will be required in your specified system. Scott customer service agents will be pleased to assist with your queries.



# Required flow rates

## CONSTANT FLOW APPARATUS

300lpm (litres per minute) per user (ie 2 users = 600lpm, 3 users = 900lpm, 4 users = 1200lpm)

## DEMAND VALVE APPARATUS

1 user = 300lpm, 2 users = 450lpm, 3 users = 750lpm, 4 users = 900lpm

## WHY THE DIFFERENCE?

Peak flow on demand = 2.5 litres (lung capacity) x 40 (breaths/min) x  $\pi$  (as breathing is effectively a sine wave) = 300lpm  
 450lpm for 2 wearers (as breathing is never in sync)

**Total usage of air will be on average 40-50 litres of air per minute**

*NB – The above flow rate requirements are those for the EUROPEAN Norm (EN). Other International Standards may differ slightly.*

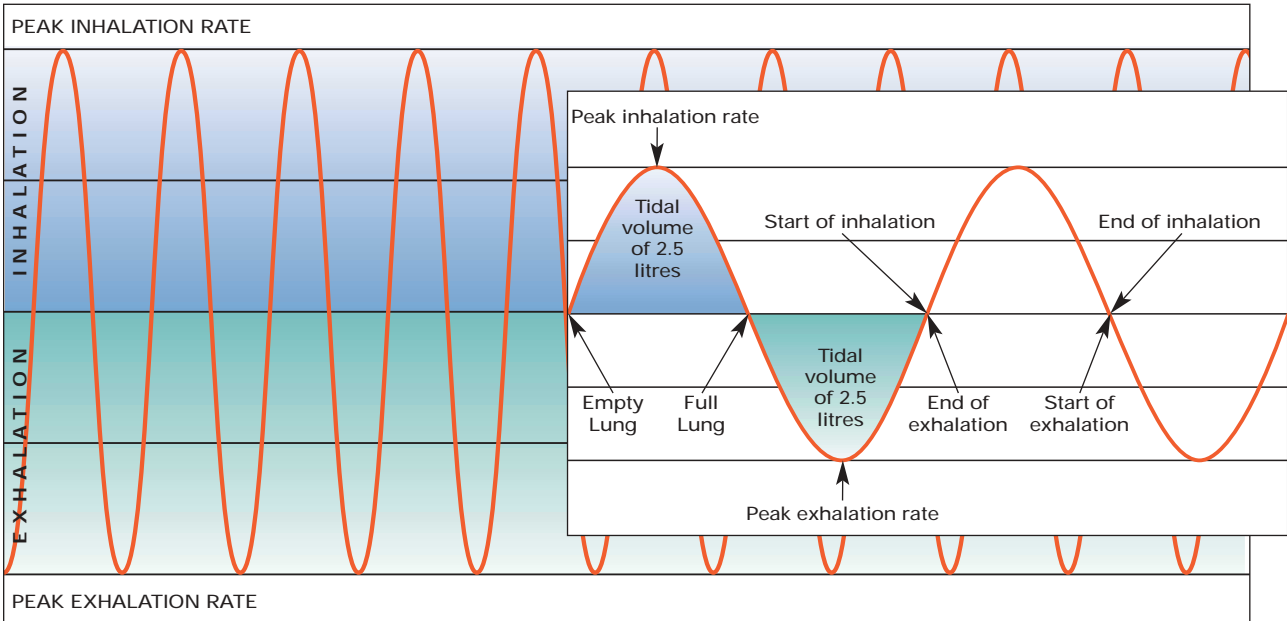

40 breaths per minute with a 2.5 litre tidal volume

# CEN couplings

CEN type couplings are the standard couplings that are used on Sabre airline equipment. These feature a safety-locking mechanism that has a single action connect, but requires a double action to disconnect.

The male couplings are fabricated from 316 grade stainless steel. The female couplings are fabricated from Nickel-plated brass with stainless steel locking balls. The female is a self-sealing coupling and can be connected and disconnected under pressure.



The female is to a 344 pattern whilst the male coupling is to a longer 341 pattern which allows compatibility with the full range of 340 series couplings.

Part number	Connection	Fitting
021.039.99	CEN Socket	1/4" Hose Tail
021.040.99	CEN Plug	1/4" BSP Male Taper thread
021.041.99	CEN Socket	1/4" Male Taper thread
021.043.99	CEN Plug	3/8" Bore Hose Tail
021.044.99	CEN Socket	3/8" Bore Hose Tail
021.045.99	CEN Socket	3/8" BSP Male Taper thread
021.047.99	CEN Plug	1/4" BSP Female Parallel thread
021.088.99	CEN Socket	1/4" BSP Male Parallel thread
021.089.99	CEN Plug	1/4" BSP Male Parallel thread

# SCBA



Self-contained breathing apparatus can also be used in conjunction with an airline by way of a simple attachment (left). This could be used to extend the working duration of the set (overcoming some of the limitations of the cylinder duration) or as a long duration escape set should the airline supply be compromised.

The Cen-paq consists of a set of pneumatics mounted in a soft, comfortable jacket. Cylinder duration options of 15, 20 and 30 minutes give the user flexibility, both in terms of weight and profile of the set.

The Contour range can also be used with an airline attachment. The advantage of this equipment is you can carry between 30-90 minutes of air as an escape reserve. Alternatively the airline system can be used to extend the duration of the BA set whilst the wearer is travelling to the point where he needs to disconnect and have the flexibility of an unconstrained BA set.

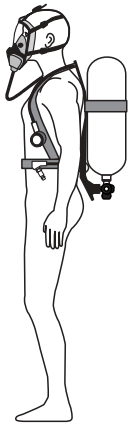

CONTOUR

- Extended duration
- Greater operational flexibility
- Low through life costs
- High performance pneumatics

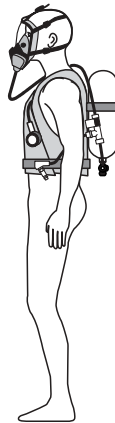

CEN-PAQ



CONTOUR



## Approvals



CEN-PAQ

Product	Approvals
Modulair	CE marked in accordance with EN139, AS1716
Flite	CE marked in accordance with EN139, AS1716
Flite with escape cylinder	CE marked in accordance with EN139 and EN402, AS1716
RAS and RAS Asbestos	CE marked in accordance with EN139, AS1716
Contour	CE marked in accordance with EN139 and EN137, AS1716, MED
Cenpaq	CE marked in accordance with EN139 and EN137, AS1716, MED



D I S T R I B U T O R



In accordance with our policy of continual product improvement, equipment supplied may differ from the specification detailed herein.



**Scott Health & Safety Ltd**  
 Pimbo Road, West Pimbo, Skelmersdale  
 Lancashire WN8 9RA, England  
 Customer Services:  
 Tel: +44 (0)1695 711711  
 Fax: +44 (0)1695 711772  
 scott.sales.uk@tycoint.com  
 www.scottsafety.com