

VINYL COATED LOCKOUT HASP

- Scissor action hasps are available in 25 mm / 38 mm Dia Jaw size.
- In these hasps, the padlock fixing section is vinyl coated for better gripping & visibility.
- Accepts padlocks with a shackle diameter up to 9 mm. 6 or more locks can be installed on each hasp; depending on the holes provided.
- Hasps are manufactured from high tensile steel sheet which are electro-plated / powder coated to prevent rusting. In Yellow black hasps, Black Powder coating is done on steel.
- Besides 6 holes, 25 mm jaw size conventional vinyl coated hasps are also available from 3 to 24 holes.*



RSG - VCH - S



RSG - VCH - P



RSG - VCH - S Y & B



RSG - VCH - P Y & B



RSG - VCH - S CR



RSG - VCH - P CR

Specification

MODEL	RSG - VCH - S	RSG - VCH - P
	VCH - S CR	VCH - P CR
	VCH - S Y & B	VCH - P Y & B
Material	Mild Steel	Mild Steel
Dia (Jaw Size)	25 mm	38 mm
Body - width	39 mm	39 mm
Body - height	114 mm	127 mm
Shackle Dia	5 mm	6 mm

MODEL	PRODUCT DESCRIPTION
RSG - VCH - S	Vinyl Coated Hasp - Small - Red (5 mm shackle)
RSG - VCH - P	Vinyl Coated Hasp - Premier - Red (6 mm shackle)
RSG - VCH - S Y & B	Vinyl Coated Hasp - Small - Yellow & Black
RSG - VCH - P Y & B	Vinyl Coated Hasp - Premier - Yellow & Black
RSG - VCH - S CR	Vinyl Coated Hasp - Small - Colour * Y / B / G
RSG - VCH - P CR	Vinyl Coated Hasp - Premier - Colour * Y / B / G



Other available colours



YELLOW GREEN BLUE

* Minimum quantity 200 Nos.

VINYL COATED LOCKOUT HASP: INTERLOCKING



RSG - VCH - S - SL



RSG - VCH - P - SL



RSG - VCH - S - DL



RSG - VCH - P - DL



RSG - ALH - 25



RSG - ALH - 38

VINYL COATED LOCKOUT HASP: ALUMINIUM

Specification

MODEL	RSG - VCH - S - SL	RSG - VCH - P - SL	RSG - VCH - P - DL	RSG - ALH - 25	RSG - ALH - 38
	RSG - VCH - S - DL				
Material	Mild Steel	Mild Steel	Mild Steel	Casted Aluminium	Casted Aluminium
Dia (Jaw Size)	25 mm	36 mm	38 mm	25 mm	38 mm
Body - width	39 mm	40 mm	39 mm	39 mm	39 mm
Body - height	114 mm	125 mm	130 mm	114 mm	127 mm
Shackle Dia	5 mm	6 mm	6 mm	5 mm	6 mm

MODEL	PRODUCT DESCRIPTION
RSG - VCH - S - SL	Vinyl Coated Hasp - Small - Single Locking
RSG - VCH - P - SL	Vinyl Coated Hasp - Premier - Single Locking
RSG - VCH - S - DL	Vinyl Coated Hasp - Small - Double Locking
RSG - VCH - P - DL	Vinyl Coated Hasp - Premier - Double Locking
RSG - ALH - 25	Aluminium Hasp - 25 mm
RSG - ALH - 38	Aluminium Hasp - 38 mm

VINYL COATED LOCKOUT HASP



RSG - VCH - 7



RSG - VCH - 12



RSG - VCH - 13



RSG - VCH - 24

Specification				
MODEL	RSG - 34 LH	RSG - 44 LH	RSG - SCORPIO	RSG - ALH - 2 WAY
Material	Mild Steel	Mild Steel	Mild Steel	Mild Steel
Dia (Jaw Size)	25 mm	25 mm	25 mm	25 mm
Body - width	39 mm	39 mm	39 mm	39 mm
Body - height	129 mm	164 mm	171 mm	262 mm
Shackle Dia	5 mm	6 mm	6 mm	6 mm



25 mm jaw size Lockout HASP can be provided with holes ranging from 3 - 24*

* Minimum quantity 200 Nos.

Other available colours



YELLOW GREEN BLUE

* Minimum quantity 200 Nos.

MODEL	PRODUCT DESCRIPTION
RSG - VCH - 7	Vinyl Coated Hasp - 7 Hole
RSG - VCH - 12	Vinyl Coated Hasp - 12 Hole
RSG - VCH - 13	Vinyl Coated Hasp - 13 Hole
RSG - VCH - 24	Vinyl Coated Hasp - 24 Hole

SCORPIO LOCKOUT HASP

Dual scissor action hasp is a type of scorpio lockout hasp with two different jaw sizes (20 mm & 45 mm of inner width) which adds to its versatility. This hasp is 5.35" in length and is made from tempered steel sheet; it accommodates up to 6 padlocks. It is available in Plated steel or in Red powder coating to resist rust. The hasp has an aluminium rivet in between which provides a smooth movement.

The hasp is also available in light weight aluminium - with 25 & 38 mm jaw sizes in chrome plated finish with 10 holes.



RSG - SCORPIO CR



RSG - SCORPIO



RSG - ALH - 2 WAY

Other available colours



YELLOW GREEN BLUE

* Minimum quantity 200 Nos.

MODEL	PRODUCT DESCRIPTION
RSG - SCORPIO	Powder Coated Scorpio Hasp - Red
RSG - SCORPIO CR	Powder Coated Scorpio Hasp - Colour Y / B / G
RSG - ALH - 2 WAY	Aluminium Hasp - 2 Way 10 Hole - Chrome Plated

4 LOCK PREMIER LABEL HASP

These RSG Patented lockout hasps require minimal effort for installation on the machine, which is to be locked out, using upto 4 padlocks. Available in 3 / 4 mm thick shackle.



RSG - 34 LH



RSG - 44 LH

MODEL	PRODUCT DESCRIPTION
RSG - 34 LH	3 mm Shackle with 4 Locks Labeled Hasp
RSG - 44 LH	4 mm Shackle with 4 Locks Labeled Hasp



Specification				
MODEL	RSG - 34 LH	RSG - 44 LH	RSG - SCORPIO	RSG - ALH - 2 WAY
Material	Stainless Steel / ABS	Stainless Steel / ABS	Mild Steel	Casted Aluminium
Dia (Jaw Size)	27/41 mm	26/40 mm	20-45 mm	25-38 mm
Body - width	49 mm	49 mm	37 mm	47 mm
Body - height	127 mm	127 mm	137 mm	150 mm
Shackle Dia	3 mm	4 mm	9 mm	5 mm

LOCKOUT HASP

STAINLESS STEEL HASP

Stainless Steel hasps are made as per internationally accepted designs. They are easy to use and acceptable at most of the isolation locking points.

RSG - VC SSH - S / P Hasps are manufactured from 304 stainless steel sheet and have a sleek aluminum rivet. They are duly vinyl coated at the padlock insert holes - for better gripping and visibility.

RSG - SSH - 25 is manufactured from 304 stainless steel sheet with a bright nickle plated finished using mixed aluminum die casted insert. Ideal for use in all industrial environments.

RSG - SSH - 25 FSS is complete Stainless Steel piece with SS rivet.

RSG - SSH Die casted 304 stainless steel hasps are most popular in industries with harsh / extreme corrosive environment. They are available in 3 & 5 mm shackle thickness sizes.



RSG - VC SSH - S



RSG - VC SSH - P



RSG - SSH - 25
RSG - SSH - 25 FSS



RSG - SSH - 25 YB



RSG - SSH - 3



RSG - SSH - 5

Specification

MODEL	RSG - VC SSH - S	RSG - VC SSH - P	RSG - SSH - 25 RSG - SSH - 25 FSS	RSG - SSH - 25 YB	RSG - SSH - 3	RSG - SSH - 5
Material	Stainless Steel	Stainless Steel	Stainless Steel / Casted Aluminium	Stainless Steel / Casted Aluminium	Stainless Steel	Stainless Steel
Dia (Jaw Size)	25 mm	38 mm	25/34 mm	25/34 mm	28/25 mm	30/29 mm
Body - width	39 mm	39 mm	49 mm	49 mm	45 mm	45 mm
Body - height	114 mm	127 mm	116 mm	116 mm	116 mm	113 mm
Shackle Dia	5 mm	6 mm	5 mm	5 mm	3 mm	5 mm



MODEL	PRODUCT DESCRIPTION
RSG - VC SSH - S	Vinyl Coated Stainless Steel Hasp - Small
RSG - VC SSH - P	Vinyl Coated Stainless Steel Hasp - Premier
RSG - SSH - 25	Stainless Steel Hasp - 25 mm
RSG - SSH - 25 FSS	Stainless Steel Hasp - 25 mm - Full Stainless Steel
RSG - SSH - 25 YB	Stainless Steel Hasp - 25 mm - Yellow Black
RSG - SSH - 3	Stainless Steel Hasp - 3 mm shackle
RSG - SSH - 5	Stainless Steel Hasp - 5 mm shackle

LOCKOUT HASP

STAINLESS STEEL TEMPER PROOF HEAVY DUTY HASP

RSG - HDH Hasps (Heavy Duty Hasps) are specially designed hasps made of marine grade 316 stainless steel. Fits to most of the switch gears & lockout gadgets with minimum 6.15 mm hole.



RSG - HDH - 7 H



RSG - HDH - 13 H



RSG - HDH - 84



RSG - HDH - 11



RSG - HDH - 13

Specification

MODEL	RSG - HDH - 7 H	RSG - HDH - 13 H	RSG - HDH - 84	RSG - HDH - 11	RSG - HDH - 13
Material	Stainless Steel	Stainless Steel	Stainless Steel	Stainless Steel	Stainless Steel
Dia (Jaw Size)	31/59 mm	27/36 mm	25/34 mm	28/25 mm	29/70 mm
Body - width	58 mm	57 mm	44 mm	60 mm	60 mm
Body - height	132 mm	145 mm	133 mm	89 mm	178 mm
Shackle Dia	5 mm	5 mm	4 mm	6 mm	6 mm

MODEL	PRODUCT DESCRIPTION
RSG - HDH - 7 H	Heavy Duty Hasp - 7 Hole
RSG - HDH - 13 H	Heavy Duty Hasp - 13 Hole
RSG - HDH - 84	Heavy Duty Hasp - 8 Hole 4 mm shackle
RSG - HDH - 11	Heavy Duty Hasp - 1 Inch x 1 Inch - 3 Locks
RSG - HDH - 13	Heavy Duty Hasp - 1 Inch x 3 Inch - 6 Locks

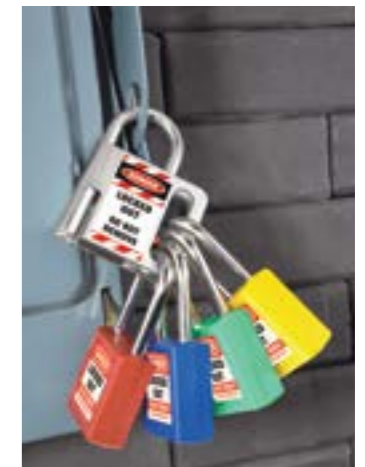

LOCKOUT HASP

STANDARD LOCKOUT HASP: RED POWDER COATED

Made from hardened steel sheets, duly powder coated in red colour. Various models are available to suit the individual requirements.



ALUMINIUM STANDARD LOCKOUT HASP: RED POWDER COATED

Non-sparking Aluminum Standard Hasps provide additional protection to areas prone to explosion. The hasps are light weight to be easily used on electrical boxes, valves and control units.

Specification						
MODEL	RSG - SH - S	RSG - SH - P	RSG - SH - S DL	RSG - SH - P SL	RSG - SH - AL 25	RSG - SH - AL 38
Material	Stainless Steel	Stainless Steel	Stainless Steel	Stainless Steel	Casted Aluminium	Casted Aluminium
Dia (Jaw Size)	25 mm	38 mm	25 mm	36 mm	25 mm	38 mm
Body - width	39 mm	39 mm	39 mm	39 mm	39 mm	39 mm
Body - height	111 mm	125 mm	114 mm	125 mm	113 mm	126 mm
Shackle Dia	5 mm	6 mm	5 mm	6 mm	5 mm	6 mm

MODEL	PRODUCT DESCRIPTION
RSG - SH - S	Standard Hasp - Small
RSG - SH - P	Standard Hasp - Premier
RSG - SH - S DL	Standard Hasp - Small - Double Locking
RSG - SH - P SL	Standard Hasp - Premier - Single Locking
RSG - SH - AL 25	Standard Hasp Aluminium - 25 mm
RSG - SH - AL 38	Standard Hasp Aluminium - 38 mm



LOCKOUT HASP

STANDARD LOCKOUT HASP: RED POWDER COATED

Made from hardened steel sheets, duly powder coated in red colour. Various models are available to suit the individual requirements.

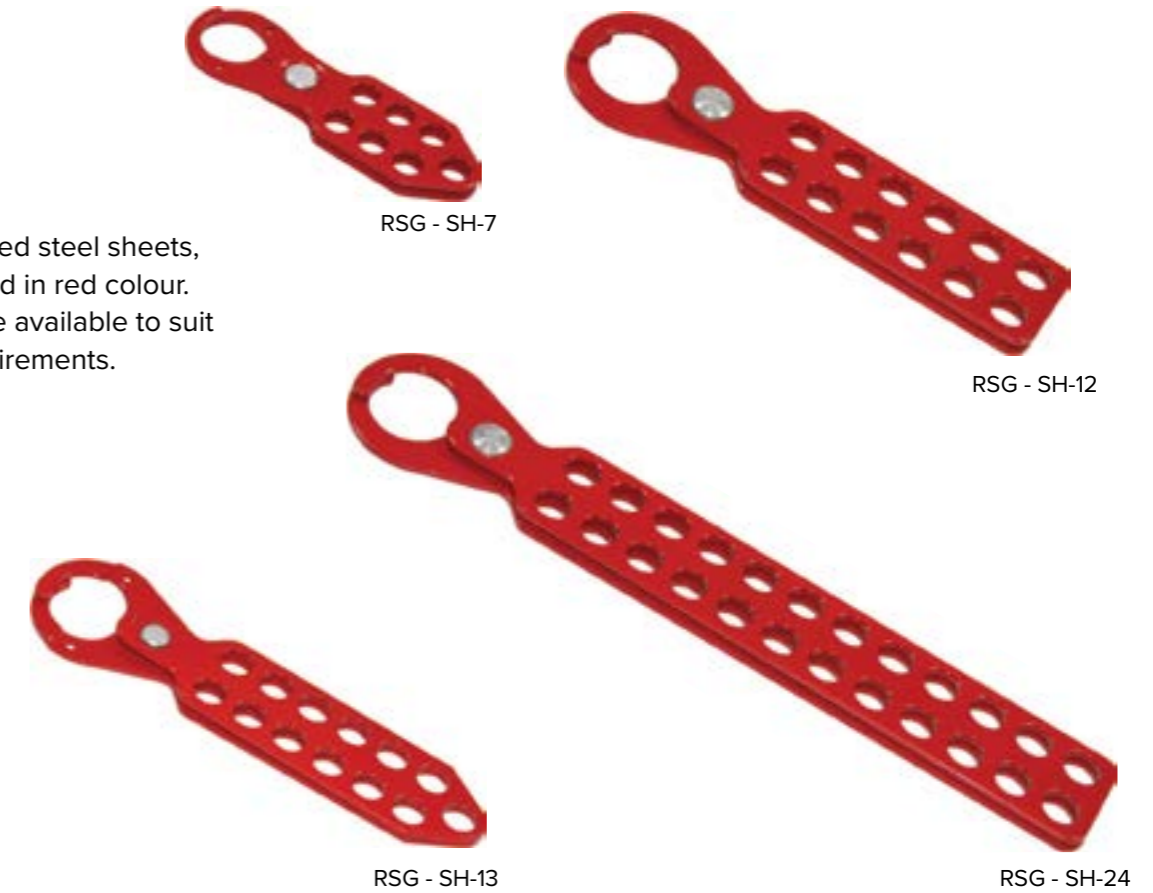

Specification				
MODEL	RSG - SH - 7	RSG - SH - 12	RSG - SH - 13	RSG - SH - 24
Material	Mild Steel	Mild Steel	Mild Steel	Mild Steel
Dia (Jaw Size)	25 mm	25 mm	25 mm	25 mm
Body - width	38 mm	38 mm	38 mm	38 mm
Body - height	128 mm	134 mm	170 mm	262 mm
Shackle Dia	5 mm	6 mm	6 mm	6 mm

MODEL	PRODUCT DESCRIPTION
RSG - SH - 7	Standard Hasp - 7 Hole
RSG - SH - 12	Standard Hasp - 12 Hole
RSG - SH - 13	Standard Hasp - 13 Hole
RSG - SH - 24	Standard Hasp - 24 Hole

 25 mm jaw size Lockout HASP can be provided with holes ranging from 3 - 24*
* Minimum quantity 200 Nos.

TAGO HASP

TAGO HASP gives the benefits of a standard hasp & a tag simultaneously. Manufactured from powder coated aluminium sheet. Supplied with one set of spare labels. Labels can be customized.



RSG - TAGOR



RSG - TAGOR6



RSG - TAGOR8



RSG - TAGOR10

Specification		
MODEL	RSG - 2-IN-1 SL HASP	RSG - 2-IN-1 DL HASP
Material	Aluminium	Aluminium
Dia (Jaw Size)	27 mm	25 mm
Body - width	77 mm	75 mm
Body - height	190 mm	171 mm
Shackle Dia	6 mm	6 mm

Other available colours



YELLOW GREEN BLUE

* Minimum quantity 200 Nos.

MODEL	PRODUCT DESCRIPTION
RSG - TAGO R	Tago Hasp - Red
RSG -L - TAGO R	Label for RSG - TAGO R
RSG - TAGO R 6	Tago Hasp - Red 6 Hole
RSG - TAGO R 8	Tago Hasp - Red 8 Hole
RSG - TAGO R 10	Tago Hasp - Red 10 Hole

TAGO 2-IN-1 HASP

Tago 2-in-1 Hasps are of great value, as one need not purchase tags and hasps individually. Built-in padlock ID system, states the workers responsible for each padlock and the reasons for the equipment being locked out. This thick gauge aluminium hasp accepts up to 8 padlocks. They are non-conductive & its red powder coating, resists chipping, fading, rust or corrosion. Interlocks prevent unauthorized removal for increased security.

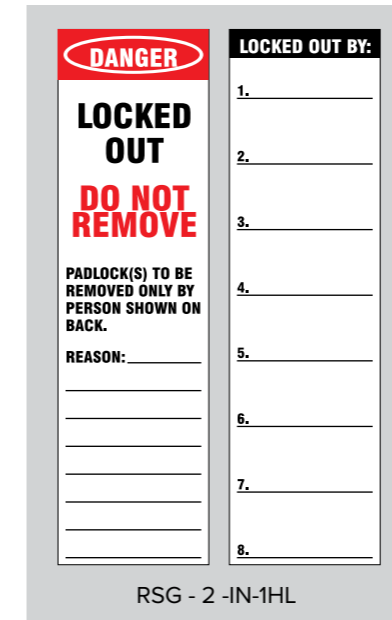

RSG - 2 -IN-1HL



Front

RSG - 2-IN-1 SL HASP

Back



RSG - 2-IN-1 DL HASP

Specification		
MODEL	RSG - 2-IN-1 SL HASP	RSG - 2-IN-1 DL HASP
Material	Aluminium	Aluminium
Dia (Jaw Size)	39 mm	39 mm
Body - width	60 mm	60 mm
Body - height	226 mm	223 mm
Shackle Dia	10 mm	10 mm

Other available colours



YELLOW GREEN BLUE

* Minimum quantity 200 Nos.

MODEL	PRODUCT DESCRIPTION
RSG - 2-IN-1 SL HASP	2-in-1 Do Not Operate Single Lockable Labeled Hasp
RSG - 2-IN-1 DL HASP	2-in-1 Do Not Operate Double Lockable Labeled Hasp
RSG - 2-IN-1 HL	2-IN-1 Hasp Label

DE - ELECTRIC SLIDER HASP



RSG Patented: De - Electric 4 hole slider designer hasp with 3 mm / 6 mm shackle sizes.
Available individually and in set of 2.
Made from hard Nylon / ABS.
Highly Visible.
Best recommended for Electrical Panels, MCBs, etc.



RSG - DESH-43

RSG - DESH-46

Slide Toggle Upwards



Open Position

Closed Position

Specification		
MODEL	RSG - DESH - 43	RSG - DESH - 46
Material	Hard Nylon / ABS	Hard Nylon / ABS
Dia (Jaw Size)	24 / 46 mm	21 / 43 mm
Body - width	61 mm	61 mm
Body - height	105 mm	105 mm
Shackle Dia	3 mm	6 mm

MODEL	PRODUCT DESCRIPTION
RSG - DESH - 43	DE - Electric Slider Hasp for 4 Locks / 3 mm Shackle
RSG - DESH - 46	DE - Electric Slider Hasp for 4 Locks / 6 mm Shackle



Other available colours



YELLOW GREEN BLUE

* Minimum quantity 200 Nos.

FLEXIBLE LOCKOUT DE - ELECTRIC HASP



Manufactured from heavy duty flexible nylon with 45 mm & 80 mm clearance.
Can easily be installed at different locations.
Ideal for difficult applications. Accepts padlocks with a shackle diameter up to 9 mm.
These hasps are Tough, Flexible, Light Weight and have additional benefit of being completely non-conductive.
Ideal for Electrical Panels, MCBs, Switches & Panel Handles.



RSG - E - HASP33

RSG - E - HASP66

RSG - E - HASP36

RSG - E - HASP65

Specification				
MODEL	RSG - E - HASP 33	RSG - E - HASP 36	RSG - E - HASP 66 & 66 CR	RSG - E - HASP 65 & 65 CR
Material	Nylon	Nylon	Nylon	Nylon
Dia (Jaw Size)	23 / 52 mm	23 / 52 mm	26 / 86 mm	26 / 80 mm
Body - width	40 mm	40 mm	43 mm	44 mm
Body - height	112 mm	115 mm	195 mm	176 mm
Shackle Dia	3 mm	6 mm	6 mm	5.5 mm

MODEL	PRODUCT DESCRIPTION
RSG - E - HASP 33	3 holes, 3 mm Shackle thickness, 45 mm clearance
RSG - E - HASP 36	3 holes, 6 mm Shackle thickness, 45 mm clearance
RSG - E - HASP 66	6 holes, 6 mm Shackle thickness, 80 mm clearance
RSG - E - HASP 66 CR	6 holes, 6 mm Shackle thickness, 80 mm clearance - Colored*
RSG - E - HASP 65	6 holes, 5.5 mm Shackle thickness, 80 mm clearance
RSG - E - HASP 65 CR	6 holes, 5.5 mm Shackle thickness, 80 mm clearance - Colored*



Other available colours



YELLOW GREEN BLUE

* Minimum quantity 200 Nos.

**NON-CONDUCTIVE
GROUP LOCKOUT
HASP**

These hasps have excellent insulating characteristics and high performance in harsh weather conditions.



MODEL	PRODUCT DESCRIPTION
RSG - GLH 3 R / Y	Group Lockout Hasp - 3 mm (R or Y)
RSG - GLH 6 R / Y	Group Lockout Hasp - 6 mm (R or Y)



**DE - ELECTRIC
DOUBLE SIDED
ECONOMY HASP**

These De-Electric hasps can accommodate 8 locks. They are similar to steel scorpio hasps, providing dual jaw sizes. These hasps are available in 8 hole conventional and 7 hole interlockable design. The interlockable economy hasps are supplied with a small lock and has 7 openings for the LOTO padlocks.



MODEL	PRODUCT DESCRIPTION
RSG - DS EH 8	Double Sided Economy Hasp - 8 Hole Nylon
RSG - DS EH 7 INT	Double Sided Economy Hasp - 7 Hole Interlocking Nylon with Lock

Specification				
MODEL	RSG - GLH 3	RSG - GLH 6	RSG - DS EH 8	RSG - DS EH 7 INT
Material	Hard Nylon/ABS	Hard Nylon/ABS	Nylon	Nylon
Dia (Jaw Size)	23 / 50 mm	20 / 47 mm	25 - 38 mm	25 - 38 mm
Body - width	mm	61 mm	58 mm	57 mm
Body - height	125 mm	126 mm	139 mm	144 mm
Shackle Dia	3 mm	6 mm	4.5 - 6 mm	4.5 - 6 mm



Other available colours



YELLOW GREEN BLUE

* Minimum quantity 200 Nos.



Cable lockouts are ideal for situations where there is a need to lockout multiple energy sources with one device or where the design/ placement of the energy sources prevents other types of lockouts from being used.

Use the flexible cable to tie off the energy source. The device holds the cable firmly and prevents it from loosening. Several padlocks can be put on the device to ensure the safety of workers.

They are flexible, cost-effective, easy-to-use, just as efficient as chains but are much lighter and visible.

MULTIPURPOSE CABLE LOCKOUT

ECONOMY MULTIPURPOSE CABLE LOCKOUT



Made of polypropylene.
Injection moulded one set construction, comprising of Stainless Steel nut and bolt for corrosion free / long lasting working.
Supplied with 2 Mtrs. Galvanized vinyl coated steel cable.
Patented easy GRIP & TWIST design.
Accepts 6 padlocks for numerous lockout applications.
Withstands Temperatures (+55° C to -20° C)
Cable can be ordered in 2 / 5 / 10 / 20 / 50 / 100 meter rolls



RSG - EML - T + 2CL



*RSG- EML + 2CL CR

25 mm jaw size Lockout HASP can be provided with holes ranging from 3 - 24*

* Minimum quantity 200 Nos.

Other available colours



YELLOW GREEN BLUE

* Minimum quantity 200 Nos.

MODEL	PRODUCT DESCRIPTION
RSG - EML	Economy Multipurpose Cable Lockout
RSG - EML + 2C	EML with 2 Mtrs. Vinyl Coated Steel Cable without loop
RSG - EML + 2C CR*	EML with 2 Mtrs. Vinyl Coated Steel Cable - Coloured (Green, Blue, Yellow etc.)
RSG - EML + 2CL	EML with 2 Mtrs. Vinyl Coated Steel Cable with Loop
RSG - EML + 2CL CR*	EML with 2 Mtrs. Vinyl Coated Steel Cable with Loop - Coloured (Green, Blue, Yellow etc.)
RSG - EML - T + 2CL	Tago Hasp - Red 6 Hole

MULTIPURPOSE CABLE LOCKOUT

UNIVERSAL MULTIPURPOSE CABLE LOCKOUT



Completely De - Electric; Can be used in multiple applications.
Scientifically made moulded section in PVC to hold 12 padlocks at any given time.
Incorporating solid stainless steel inserts.
It strongly hold's the vinyl coated galvanized steel cable in every environmental condition.
Cable can withstand more than 100 Kg weight.
Supplied with 2 Mtrs. cable of 4 mm thickness.
Cable from 3 to 6 mm can be used with this device.



RSG- UMCL - YB

RSG- UMCL + 2C

25 mm jaw size Lockout HASP can be provided with holes ranging from 3 - 24*

* Minimum quantity 200 Nos.

MODEL	PRODUCT DESCRIPTION
RSG- UMCL - YB	Universal Multipurpose Cable Lockout - Yellow Black
RSG- UMCL + 2C	UMCL Supplied with 2 Mtrs. 4 mm PVC Coated Steel Cable

PREMIER MULTIPURPOSE CABLE LOCKOUT



Can be used as a Hasp and Cable Lockout - Ideal for Multiple Applications.
Scientifically made moulded section of PVC to befit human palm.
Incorporating solid steel die cut insert for holding the looped vinyl coated galvanized steel cable at one point.
Galvanized steel cable withstands more than 100 Kg weight.
Additional 2 / 5 / 10 / 20 / 50 / 100 Mtrs. cable can be ordered separately.



RSG- PML+ 2CL

25 mm jaw size Lockout HASP can be provided with holes ranging from 3 - 24*

* Minimum quantity 200 Nos.

MODEL	PRODUCT DESCRIPTION
RSG - PML	Premier Multipurpose Cable Lockout (without cable)
RSG - PML+ 2CL	PML with 2 Mtrs. Vinyl Coated Steel Cable with Loop

**SQUEEZER
MULTIPURPOSE
CABLE LOCKOUT**



This cable lockout has been ergonomically designed to befit a human palm, making its placement and use - fast and simple. Generally supplied with 1 Mtr. cable (Customized lengths can be supplied against order).
Route the cable - where necessary to lockout the device, then insert the cable from the top. When the cable is tight and the source is locked out, squeeze the handle and apply a padlock.
Available in Vinyl coated steel core (Blue) cable and NYLON core DE - Electric (Yellow) cable versions for all kinds of locking.



RSG- SMCL - MB



Steel Cable



RSG- SMCL - DE - Y



Nylon Cable



25 mm jaw size Lockout HASP can be provided with holes ranging from 3 - 24*

* Minimum quantity 200 Nos.

MODEL	PRODUCT DESCRIPTION
RSG - SMCL - MB	Squeezor Multipurpose Cable Lockout - Metallic Blue Cable
RSG - SMCL - DE - Y	Squeezor Multipurpose Cable Lockout - DE Electric - Yellow

**GRIP TYPE
INTER LOCKABLE
MULTIPURPOSE
CABLE LOCKOUT**



Completely DE - Electric.
Used for Multiple applications.
Scientifically made moulded section in PVC to hold 4 padlocks at any given time.
Incorporating solid stainless steel inserts for holding the vinyl coated galvanized steel cable in any environment.
Supplied with 2 / 5 meter cable of 3.5 mm thickness.
Comes with Interlocking facility and brass tip of cable.



RSG-GTML+2C



25 mm jaw size Lockout HASP can be provided with holes ranging from 3 - 24*

* Minimum quantity 200 Nos.

MODEL	PRODUCT DESCRIPTION
RSG - GTMCL + 2C	Grip Type Multipurpose Cable Lockout with 2 Mtrs. Vinyl Coated Steel Cable
RSG - GTMCL + 5C	GTMCL with 5 Mtrs. of Vinyl Coated Steel Cable

MULTIPURPOSE CABLE LOCKOUT

7 HOLE MULTIPURPOSE CABLE LOCKOUT

- Flexible, cost-effective cable lockout used to lock out multiple points.
- Lighter than chains; devices are easy to carry and use.
- Cable is made of steel with insulated cover.
- Standard Cable length is 2 Mtrs. (Extra Length is available on order).
- Supplied with loop.
- Made of ABS.



RSG- 7H MCL + 2CL

RSG- 7H HMCL + 2CL

MODEL	PRODUCT DESCRIPTION
RSG - 7H MCL	7 Hole - Multipurpose Cable Lockout
RSG - 7 H MCL + 2CL	7H MCL with 2 Mtrs. Vinyl Coated Steel Cable with Loop
RSG - 7H HMCL	7 Hole Hasp type - Multipurpose Cable Lockout
RSG - 7H HMCL + 2CL	7H HMCL with 2 Mtrs. Vinyl Coated Steel Cable with Loop



Customized Cable Length can be ordered

RAZOR MULTIPURPOSE CABLE LOCKOUT



This multipurpose cable lockout device, uses a scissor action on the supplied cable. Supplied with 2 Mtrs. looped galvanized vinyl coated steel cable.

- A unique design, easy to handle - special grade hard PVC moulded one set construction -has provision for 4 locks. Extra cable of 5 / 10 Meter are available on request.
- Finger curves and thumb rest makes it easy to use.



RSG- RMCL + 2C

MODEL	PRODUCT DESCRIPTION
RSG - RMCL	Razor Multipurpose Cable Lockout
RSG - RMCL + 2C	RMCL with 2 Mtrs. Vinyl Coated Steel Cable with Loop



Customized Cable Length can be ordered

MULTIPURPOSE CABLE LOCKOUT

MOUSE TYPE CABLE LOCKOUT



This device is perfect for difficult lockout situations such as large gate valves or oversized devices. Simply route the cable through the lockout points and insert it back into the device, squeeze the black part to tighten the cable and insert the padlock.

Body is made of impact modified nylon. Standard lockout device comes with 2 Meter x 6 mm diameter cable. (5, 10 or 20 Meter cable can be ordered separately).



RSG- MTCL + 2C6



RSG- MTCL + 2C4



MTCL is available in 4 mm & 6 mm dia Cable

MODEL	PRODUCT DESCRIPTION
RSG - MTCL + 2C4	Mouse Type Cable Lockout with 2 Mtrs. 4 mm Vinyl Coated Steel Cable
RSG - MTCL + 2C6	Mouse Type Cable Lockout with 2 Mtrs. 6 mm Vinyl Coated Steel Cable



Customized Cable Length can be ordered

MULTIPURPOSE CABLE LOCKOUT

ECONOMY METALLIC MULTIPURPOSE CABLE LOCKOUT

- Made of Brass / Stainless Steel (non corrosive)
- Each device consists of 2 meter long, stainless steel cable with the locking device.
- Once fitted, the cable is clamped using tamper-proof screw with the special key provided.
- TMMCL / LMMCL and it's handle are made of 304 grade Stainless Steel.
- Stainless Steel Cable Lockouts are durable and resist rust or corrosion.



RSG- EMMCL + 2C



RSG- LMMCL + 2CL + T



RSG- TMMCL + 2C

MODEL	PRODUCT DESCRIPTION
RSG - EMMCL + 2C	Economy Metallic Multipurpose Cable Lockout with 2 Mtrs. SS Cable
RSG - LMMCL + 2CL + T	Lattu MMCL with 2 Mtrs. SS Cable with Loop and Tool
RSG - T - LMMCL	Special operating Tool for LMMCL
RSG - TMMCL + 2C	Twister Metallic Multipurpose Cable Lockout with 2 Mtrs. SS Cable



Customized Cable Length can be ordered

MULTIPURPOSE CABLE LOCKOUT

METALLIC MULTIPURPOSE CABLE LOCKOUT

- Best for Outdoors - Corrosive & Harsh Industrial Environment.
- Specially Moulded, Metallic construction comprising of Stainless Steel nut for corrosion free / long lasting working.
- 4 piece Moulded set; Easy to install and lockout.
- Open ended Stainless Steel cable is used with MMCL.
- SS cable has to be ordered as required, in 2 / 5 or 10 meter lengths.
- Most suitable for locking large size gate valves of all types.
- Totally dependable; Worldwide appreciated design.
- Also recommended for off shore installations.

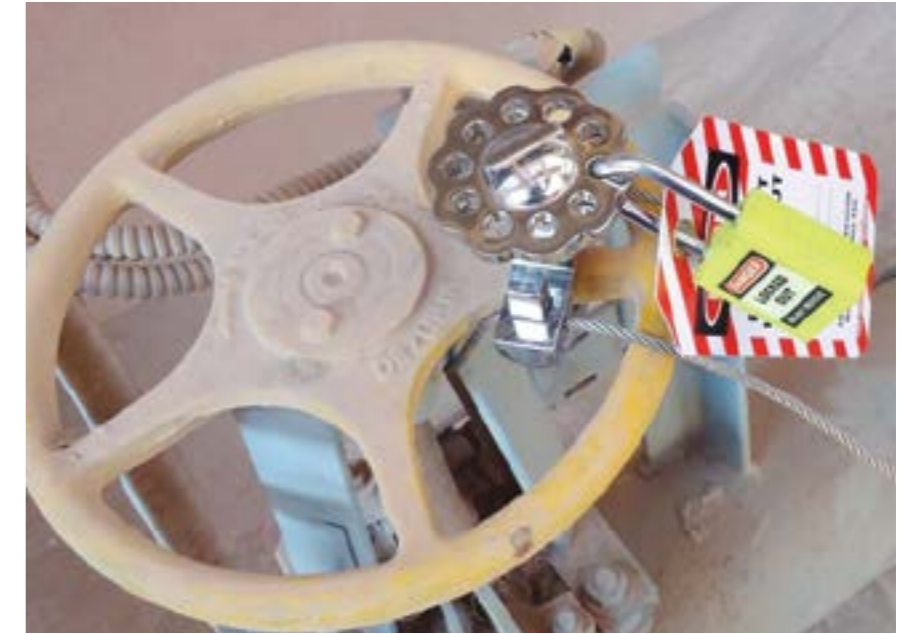

RSG- MMCL + 2C



RSG- MMCL

MODEL	PRODUCT DESCRIPTION
RSG - MMCL	Metallic Multipurpose Cable Lockout
RSG - MMCL + 2C	MMCL with 2 Mtrs. Stainless Steel Cable
RSG - 2 C for MMCL	2 Mtrs. Stainless Steel Cable for MMCL
RSG - 5 C for MMCL	5 Mtrs. Stainless Steel Cable for MMCL



Customized Cable Length can be ordered

MULTIPURPOSE CABLE LOCKOUT

STAINLESS STEEL/ VINYL COATED STEEL/ DE ELECTRIC CABLES

WITH OR WITHOUT LOOP

Also Available:

Stainless
Steel Cable



Vinyl Coated
Steel Cable



Vinyl Coated
De Electric Cable



- For LOCKOUT purpose, some time small or large cables are required in Vinyl coated steel /Stainless Steel / De electrical cables with or without the loops.
- They can be ordered in any lengths from 1 feet to 200 meters.
- Vinyl coated steel cables are mostly available in Red colour.



MODEL	PRODUCT DESCRIPTION
RSG - VSC WL	Vinyl Coated Steel Cable Without Loop
RSG - VSC OSL	Vinyl Coated Steel Cable with One Side Loop
RSG - VSC BSL	Vinyl Coated Steel Cable with Both Side Loop
RSG - SSC WL	Stainless Steel Cable Without Loop
RSG - SSC OSL	Stainless Steel Cable with One Side Loop
RSG - SSC BSL	Stainless Steel Cable with Both Side Loop
RSG - VDEC WL	Vinyl Coated De Electric Cable Without Loop
RSG - VDEC OSL	Vinyl Coated De Electric Cable with One Side Loop
RSG - VDEC BSL	Vinyl Coated De Electric Cable with Both Side Loop



Customized Cable
Length can be ordered

VALVE LOCKOUT



Valve lockouts are simple and effective in order to prevent unauthorized operation of valves. Valves come in a huge range of shapes, sizes and methods of operation. Whether you have Ball Valves, Gate Valves, Plug Valves, Globe Valves or Butterfly Valves; their method of operation determine the lockout device for the valve. Several valves are manually operated via a handwheel / lever / wrench or the valve might be power actuated e.g. electric motor, hydraulic or pneumatic actuator. Regardless of the method of operation, all valves can be locked out by our various available lockout solutions.

GATE VALVE LOCKOUT

- Virtually indestructible valve covers.
- Once locked, they rotate freely around the hand wheel & prevent the valve wheel from being turned.
- The strong polyurethane plastics make them resistant to cracking and abrasion.
- They are resistant to extreme weather and temperature conditions.
- Available in 5 sizes (Red color) Other colors are available on request (minimum quantity applicable).
- Padlock holes are available in each gate valve lockout device.
- Withstands temperatures from - 20°F to 200°F.
- Unique knockout center accommodates OS & Y or “rising stem” valves.
- Hasps and padlocks can be used to lock these lockouts.



Make a cutout with sharp blade for accommodating rising spindle stem valves

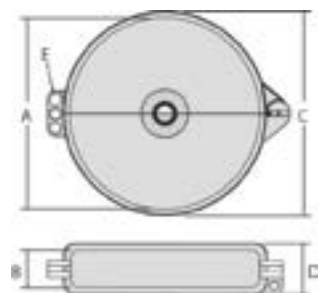

Dimension				
MODEL	RSG - GLH 3	RSG - GLH 6	RSG - DS EH 8	RSG - DS EH 7 INT
Material	Hard Nylon/ABS	Hard Nylon/ABS	Nylon	Nylon
Dia (Jaw Size)	23 / 50 mm	20 / 47 mm	25 - 38 mm	25 - 38 mm
Body - width	63 mm	61 mm	58 mm	57 mm
Body - height	125 mm	126 mm	139 mm	144 mm
Shackle Dia	3 mm	6 mm	4.5 - 6 mm	4.5 - 6 mm

Other available colours

YELLOW GREEN BLUE

* Minimum quantity 200 Nos.

MODEL	GVL: Gate Valve Lockout
RSG - 02 - GVL	Fits on handle wheel dia from 25 to 63.5 mm (1" - 2½" inch)
RSG - 04 - GVL	Fits on handle wheel dia from 63.5 to 127 mm (2½" - 5" inch)
RSG - 06 - GVL	Fits on handle wheel dia from 127 to 165 mm (5" - 6½" inch)
RSG - 08 - GVL	Fits on handle wheel dia from 165 to 254 mm (6½" - 10" inch)
RSG - 10 - GVL	Fits on handle wheel dia from 25 to 63.5 mm (1" - 2½" inch)

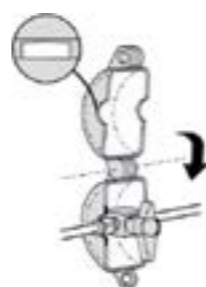

METALLIC MULTIPURPOSE CABLE LOCKOUT

It adjusts to fit gate valves from 2.5 to 16.5 cm (1" to 6½" gate valve hand wheels) & 16.5 to 37.5 cm (6.5" to 14.75" gate valve hand wheels). Covers and rotates freely around the valve's wheel. Made of durable polypropylene / ABS. Resistant to extreme temperature changes - 13°F to +194°F. Compact design for easy carrying and storage.



RSG-AGV



RSG-AGV-SC



RSG-AGV-BC

Other available colours

YELLOW GREEN BLUE

* Minimum quantity 200 Nos.

MODEL	GVL: Gate Valve Lockout
RSG - AGV	Adjustable Gate Valve Lockout - Conventional (25 mm - 165 mm)
RSG - AGV - SC	Adjustable Gate Valve Lockout - Small with Cutout (25 mm - 165 mm)
RSG - AGV - BC	Adjustable Gate Valve Lockout - Big with Cutout (165 mm - 380 mm)

BALL VALVE LOCKOUT



- These easy to use lockouts, clamp over the valve lever - preventing the valve from being operated. BV - 01 can lock the small sized valves in both open or closed positions, whilst the larger BV - 01 EX / BV - 02 L can only be used in the closed position.
- These two piece, moulded lockouts can be installed on most of the ball valves available internationally.
- They are virtually indestructible. Inner slider is used for gripping the valve handle sleeves inside the cover.
- Once locked, they prevent valve handle from being turned.
- The strong polyurethane plastic make them resistant to cracking and abrasion.
- They are resistant to extreme weather & temperature conditions.
- Non conductive. Available in 4 colours.



MODEL	PRODUCT DESCRIPTION
RSG - BV 01	For Ball Valve - Pipe Dia 3/8" - 1/4" (Max Handle length 7 1/2")
RSG - BV 01 EX	For Ball Valve - Pipe Dia 1 1/2" - 2 1/2" (Max Handle length 10")
RSG - BV 02 L	For Ball Valve - Pipe Dia 2" - 8" (Large Size)

TOP RAIL BALL VALVE LOCKOUT



- Small Ball Valve Lockout device locks out the valves (for 12.5 to 31 mm dia pipes) in open or closed position.
- Large Ball Valve Lockout device locks out the valves (for 50 to 200 mm dia pipes) in closed position only.



MODEL	TR BVL : Top Rail Ball Valve Lockout
RSG - TR BVL - S	For Ball Valve Dia 1/2" - 1 1/4" (Max Handle length 8")
RSG - TR BVL - L	For Ball Valve Dia 2 - 8 (Max Handle length 10")

Other available colours

YELLOW GREEN BLUE

* Minimum quantity 200 Nos.

STANDARD BALL VALVE LOCKOUT



RSG- 2PP - SBVL



RSG- 1PS - S BVL



RSG- 1PS - L BVL

- They lock quarter - turn ball valves in OFF position.
- They virtually fit on valve levers up to 76 mm wide.
- RSG - 1PS - S BVL & RSG - 1PS - L BVL are made of powder coated steel.
- RSG - 2PP - SBVL is made of super tough nylon.



Other available colours

YELLOW GREEN BLUE

* Minimum quantity 200 Nos.

Dimension			
MODEL	RSG - 1PS - S BVL	RSG - 1PS - L BVL	RSG - 2PP - SBVL
Max Shackle Dia	3/8"	9/32"	9/32"
Pipe Dia	1/4" to 1"	1-1/4" to 3"	1/4" to 1"
Max Handle Width	1-1/2"	21/10"	1-1/2"
Max Handle Thickness	3/4"	11/4"	3/4"

MODEL	PRODUCT DESCRIPTION
RSG - 2PP - SBVL	Two Piece PVC - Small Ball Valve Lockout
RSG - 1PS - S BVL	One Piece Steel - Small Ball Valve Lockout
RSG - 1PS - L BVL	One Piece Steel - Large Ball Valve Lockout

SETTABLE BALL VALVE LOCKOUT



- Used for precise Locking & closing / opening of the ball valves of various sizes and makes.
- Constructed from super tough nylon and stainless steel to avoid corrosion. Designed to lock out quarter-turn valves of varying sizes and geometric handle dimensions (round, square or flat) up to 1 - 1/4" thick x 1-5/8" wide and various lengths. Valves can also be locked in the ON or fixed positions for non lockout applications. To freeze the valve handle at an exact location attach the second Arm (Sold separately) to lock handle of 2 / 3 / 4 or 5 way Valves.
- Ideal for all kinds of usage areas / pipelines like gaseous, oils, liquids, air pressure pipes & valves etc.



RSG-SSBVL - SET (Small)



RSG-LSBVL - SET (Large)



RSG-SMALL - ARM



RSG-LARGE - ARM



RSG-SMALL - ARM - EX



RSG-LARGE - ARM - EX

MODEL	PRODUCT DESCRIPTION
RSG - SSBVL - SET (Small)	Small Size Settable Ball Valve Lockout - with Small Arm
RSG - LSBVL - SET (Large)	Large Size Settable Ball Valve Lockout - with Large Arm
RSG - SMALL - ARM	Additional Arm - Small (with 4.5" SS Rod)
RSG - SMALL - ARM - EX	Additional Arm - Small - Extended (with 10.25" SS Rod)
RSG - LARGE - ARM	Additional Arm - Large (with 5.75" SS Rod)
RSG - LARGE - ARM - EX	Additional Arm - Large - Extended (with 10.25" SS Rod)



UNIVERSAL VALVE/ CABLE LOCKOUT

- Versatile, rugged, easy to use, lightweight and chemical resistant lockout device.
- It's open ended clamp fits over closed rings, wide handles and large levers, T-handles and other hard-to-secure mechanical devices.
- Use two blocking arms to lock out 3 / 4 / 5 way valves.
- Injection moulded - special PVC grade / stainless steel components embedded Lockout.
- The clamp attaches to the butterfly valve lever, preventing the trigger handle from being squeezed.
- Multiple functioning with the help of vinyl coated steel cable and arms.
- Use cable attachment to lockout gate valves.
- Made from industrial grade stainless steel and nylon for rugged durability; giving chemical and corrosion resistance.
- This Universal Lockout is a modular construction which allows the user to add various accessories to make the device suitable for a large range of valves.
- Arms are available in different Stainless Steel Rod lengths / sizes.

Use as a Butterfly Valve Lockout



Clamp attaches to butterfly valve lever, preventing trigger handle from being squeezed. Valve cannot be repositioned.

RSG-UVL

Use as a Gate Valve Lockout

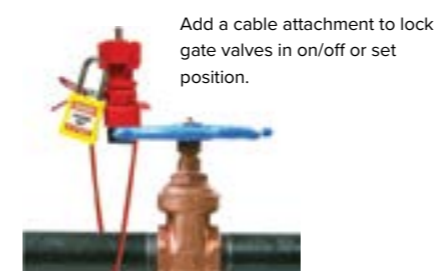

Add a cable attachment to lock gate valves in on/off or set position.

RSG-UVL + C

Use as a Ball Valve Lockout

Use two locking arms to lockout 3 / 4 or 5-way valves or to lock valves in the throttled position for operational control.



RSG-UVL + 2SA



MODEL	PRODUCT DESCRIPTION
RSG - UVL	Universal Valve Lockout
RSG - UVL + C	UVL with 2 Mtrs. Galvanized Steel Cable
RSG - UVL + C + LA	UVL with 2 Mtrs. Galvanized Steel Cable and Large Arm
RSG - UVL + SA	UVL with Small Arm
RSG - UVL + 2SA	UVL with 2 Small Arm
UVL + LA	UVL with Large Arm

BUTTERFLY VALVE LOCKOUT CONVENTIONAL



When slid into position, the wedge on the slider section prevents the compression handle from being squeezed, preventing operation of the valve. Padlock is placed through the holes to ensure proper lockout. Hasps maybe used when multiple locking is required.

- Designed to lock most kinds of butterfly valves in the industries.
- Resistant to cracking and abrasion. Highly resistant to solvent and other chemical products.
- Available in 4 colours.
- Made of strong polypropylene plastic; Fully de - electric (non - conductive).
- They are resistant to extreme weather and temperature conditions making them suitable for outdoors.



RSG - BFV 04



Other available colours



YELLOW GREEN BLUE

* Minimum quantity 200 Nos.

MODEL	PRODUCT DESCRIPTION
RSG - BFV 04	Butterfly Valve Lockout

UNIVERSAL BUTTERFLY VALVE LOCKOUT



RSG - UBFVL Y



RSG - UBFVL R



RSG - UBFVL - COMBO

- This lockout device jams the valve lever release trigger. (Place UBFVL between the valve lever and release trigger & hinge open until the two parts jack the valve lever and release trigger to a frizzed position).
- Use a RSG - GTMCL + 2C cable lockout to secure the device in place by passing the cable around the valve body and through the matching hole of UBFVL. Place the padlocks on GTMCL and secure the device.
- This product is also known as butterfly valve handle jammer. Available in Red & Yellow colours.
- The complete set is RSG - UBFVL - COMBO which comprises of the lockout device with cable lockout.



Best for >>



MODEL	PRODUCT DESCRIPTION
RSG - UBFVL	Universal Butterfly Valve Lockout (Red & Yellow)
RSG - UBFVL - COMBO	UBFVL with RSG - GTMCL + 2C

**PLUG VALVE/
GLOBE VALVE
LOCKOUT**



Plug Valve Lockout secures a manually actuated plug valve with a stem diameter between 9.5 mm - 63.5 mm easily and effectively. The base of this lockout device remains in place on application and does not interfere with valve activation by removable handle / wrench. These devices are made of durable polypropylene. They are compact in size, highly visible and easy to use.



RSG - PVL 922



RSG - PVL 2334



RSG - PVL 4454



RSG - PVL 5563

MODEL	PRODUCT DESCRIPTION
RSG - PVL 922	Plug Valve Lockout (9.50 - 22.20 mm)
RSG - PVL 2334	Plug Valve Lockout (23.80 - 34.90 mm)
RSG - PVL 4454	Plug Valve Lockout (44.50 - 54.00 mm)
RSG - PVL 5563	UBFVL with RSG - GTMCL + 2C



No need to match your lockout device for varying diameters and threads of cylinder caps. Our gas cylinder lockout is adjustable and installs in seconds.

CYLINDER LOCKOUT

GATE VALVE CYLINDER LOCKOUT



RSG - GVCL

- Designed with stem hole dia of 29 mm, made of polystyrene plastic.
- Prevents access to the valve handle.
- Easy application.
- Used to lockout propane cylinders on Forklift trucks.
- Designed to fit in tight spaces. Single padlock can be applied.
- GVCL with padlock cap.



MODEL	PRODUCT DESCRIPTION
RSG - GVCL	Gate Valve Cylinder Lockout

CYLINDER LOCKOUT

- Easy application.
- Prevent access to the valve handle.
- The unit encloses the valve head and is locked in place with two interlocking plates.
- Installed in seconds and provides quick and easy identification of a full /empty cylinder. Additional function of applying a padlock to lock the device in place, to prevent unauthorized activation of the valve.
- Inner size - 85 mm dia x 150 mm depth.
- Designed with the stem hole dia of 35 mm.
- Made of polystyrene plastic.



RSG - CLO - Y



RSG - CLO - R



RSG - CLO - F



RSG - CLO - E

MODEL	PRODUCT DESCRIPTION
RSG - CLO - Y	Cylinder Lockout (Yellow Lid)
RSG - CLO - R	Cylinder Lockout (Red Lid)
RSG - CLO - F	Cylinder Lockout (Green Lid - Full)
RSG - CLO - E	Cylinder Lockout (Red Lid - Empty)

Used for PLUG / GLOBE valve lockout also



RSG - VCLO + EML



RSG - CLO - CUS

MODEL	PRODUCT DESCRIPTION
RSG - VCLO + EML	Valve Cylinder Lockout + RSG - EML with 2.5 Mtrs. Cable
RSG - CLO - CUS	Customised Cylinder Lockout

3 Hole Interlocking cylinder lockout cover

PNEUMATIC LOCKOUT



RSG - PL 3W

Isolate pneumatic energy without the expense and inconvenience of installing in-line lockout valves. These quick connectable lockouts are applied to the male fittings, isolating equipment from all compressed air sources.

PNEUMATIC LOCKOUT BOX TYPE



- Accommodates male air hose connectors as well as their electrical plugs (110 V, 220 V, 550 V Plugs).
- Made of Polystyrene / ABS material; 4 padlocks can be applied.
- Ensures that the male air hose connectors & the plug can't be used until the lock is removed.



RSG - SPLO



RSG - LPLO

MODEL	PRODUCT DESCRIPTION
RSG - SPLO	Small Pneumatic Lockout
RSG - LPLO	Large Pneumatic Lockout



PNEUMATIC LOCKOUT

This uniquely designed pneumatic lockout fits virtually on all pneumatic fittings used in manufacturing facilities. The pneumatic lockout is applied to the fitting to prevent it from being reconnected to the pressurized air source.

- Made from Stainless Steel solid sheets - to make them strong, durable and resistant to corrosion.
- Easy to use, just place over the male fittings between the two parts and apply your lockout padlock.

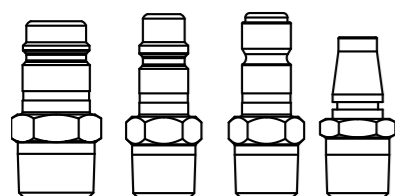
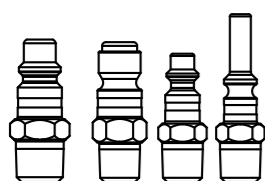

RSG - PL 9 H

MODEL	PRODUCT DESCRIPTION
RSG - PL 9 H	Pneumatic Lockout - Straight with 9 Holes

Hole Sizes (mm dia.)

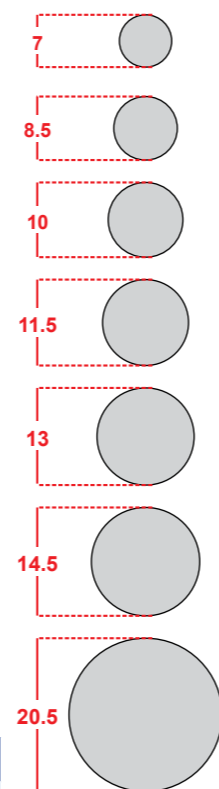

Plug lockouts prevent electrical plugs from being inserted into a wall outlet. It is used when the plug is not under the exclusive control of the person performing service or maintenance.

ELECTRICAL PLUG LOCKOUT BOX TYPE

Manufactured from sturdy polystyrene / ABS, these units have been developed to completely enclose electrical plugs to prevent a machine from being energized. The plug completely sits inside the unit with the cable being fed through an access hole. The small unit is suitable for a variety of electrical connections up to 40 mm diameter, with a locking mechanism that can accommodate up to 4 safety padlocks. The large unit is suitable for standard and larger electrical plugs, including 3 phase connectors.

- Plug lockout prevents electrical plugs from being inserted into a wall outlet.
- Small 110V plug lockout : 80 H x 44 D x 42 W mm with ½” diameter hole for cable.
- Large 220V / 500V plug lockout : 155 H x 86 D x 84 W mm with 8.5 to 19 diameter holes for cable.
- Completely encloses electrical plugs to prevent accidental re-connection.



RSG - SPLO



RSG - LPLO



Other available colours

YELLOW GREEN BLUE

* Minimum quantity 200 Nos.

MODEL	PRODUCT DESCRIPTION
RSG - SPLO	Small Plug Lockout
RSG - LPLO	Large Plug Lockout

ELECTRICAL PLUG LOCKOUT PREMIER

Manufactured from sturdy polystyrene / ABS, these units have been developed to completely enclose electrical plugs to prevent a machine from being energized. The plug completely sits inside the unit with the cable being fed through an access hole.

The small unit is suitable for a variety of electrical connections up to 40 mm diameter, with a locking mechanism that can accommodate up to 4 safety padlocks. The large unit is suitable for standard and larger electrical plugs, including 3 phase connectors.

- Plug lockout prevents electrical plugs from being inserted into a wall outlet.
- Small 110V plug lockout : 2” H x 2” D x 3½” W with ½” diameter hole for cable.
- Large 220V / 500V plug lockout : 3¼” H x 3¼” D x 7” W with 1” diameter hole for cable.
- Completely encloses electrical plugs to prevent accidental re-connection.



RSG - SPLO - P



RSG - LPLO - P

Other available colours

YELLOW GREEN BLUE

* Minimum quantity 200 Nos.

MODEL	PRODUCT DESCRIPTION
RSG - SPLO - P	Small Plug Lockout - Premier
RSG - LPLO - P	Large Plug Lockout - Premier

CYLINDER ELECTRICAL PLUG LOCKOUT

- Unique device prevents plugs from being 'plugged in' until intentionally removed.
- Slip plug into the chemical-resistant plastic cylinder; close one or both cover plates for a snug fit and secure with Padlock.
- Fits any plug up to 600 volts, 5-7/8" x 3" dia.
- Lockout devices are supplied with instructions.



RSG - CLO - EL



MODEL	PRODUCT DESCRIPTION
RSG - CLO - EL	Cylinder Electrical Plug Lockout

PLUG COVER
LOCKOUT

- These Large Plug Cover Lockouts are made of special grade non tearable red fabric & black riveted leather encased belt.
- They can be supplied on request with solid PVC pipe insert, of suitable dia to avoid unwanted operation of the control buttons of hoist of cranes etc. (at an extra cost)



RSG - SPCL



RSG - LPCL



Using pipe is most recommended to avoid any intentional operation of switches.

Specification				
Model	RSG - SPCL	RSG - LPCL	RSG - SPCL + P	RSG - LPCL + P
Width	9 inch	9 inch	9 inch	9 inch
Length	18 inch	25 inch	18 inch	25 inch
Pipe Dia			5 inch	5 inch
Pipe Length			12 inch	20 inch

MODEL	PRODUCT DESCRIPTION
RSG - SPCL	Small Plug Cover Lockout - Red
RSG - SPCL + P	Small Plug Cover Lockout - with Pipe
RSG - LPCL	Large Plug Cover Lockout - Red
RSG - LPCL + P	Large Plug Lockout



RSG - LPCL + P



These patented new designs of Electrical Lockout Devices are ideal for locking out Pin and Sleeve surface mounted or trailing sockets & Plugs. They prevent electrical accidents and the unauthorised usage of plugs during servicing / maintenance. Commonly used in Industries like - Steel, Bottling, Engineering, Cement, Mining, Processing, Automobile, Offshore, Dairy, Manufacturing, etc.

**PIN & SLEEVE
SOCKET LOCKOUT**

RSG - P&S - SL: Simply insert the locking device into the FEMALE SOCKET. Bring over the socket flap to hold it in place and lock it with suitable Lockout Hasp & Padlock.

FEATURES:

- OSHA Lockout / Tagout regulation 29CFR 1910.147 Compliant.
- RSG - P&S - SL are available in 4 sizes to block socket of 110V, 16 Amp to sockets of 400 V, 63 Amp (to accommodate a full range of electrical plug designs and ratings) Protect against unexpected start up of equipment during maintenance and repair work.
- Discourages unauthorized use of tools and equipment.
- Made in High-visibility red / yellow colour for easy identification.
- These reusable and durable product are made from polypropylene.
- Supports good practice in the control of hazardous energy and 'lockouttagout' procedures (LOTO).

**CEEtyp Clockface Positions in Accordance
with IEC 309-2 and UL 1686**

North American Rating Voltage AC (Except where noted)

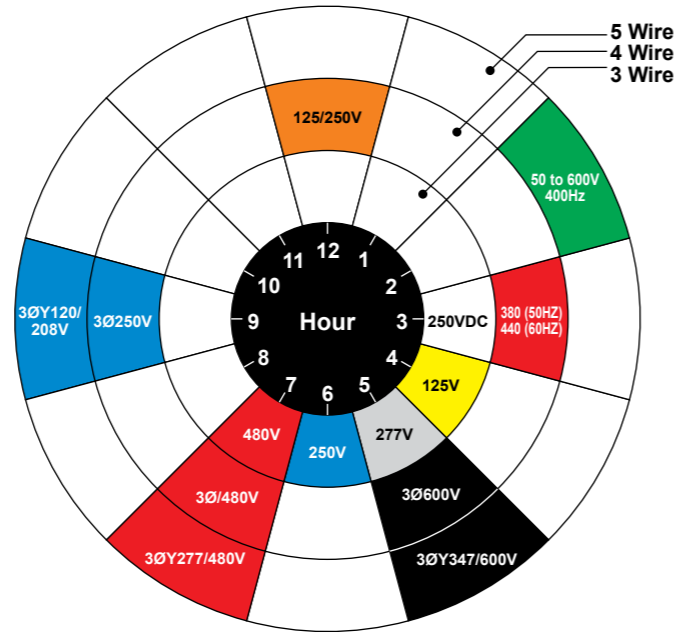

International Rating Voltage AC (Except where noted)

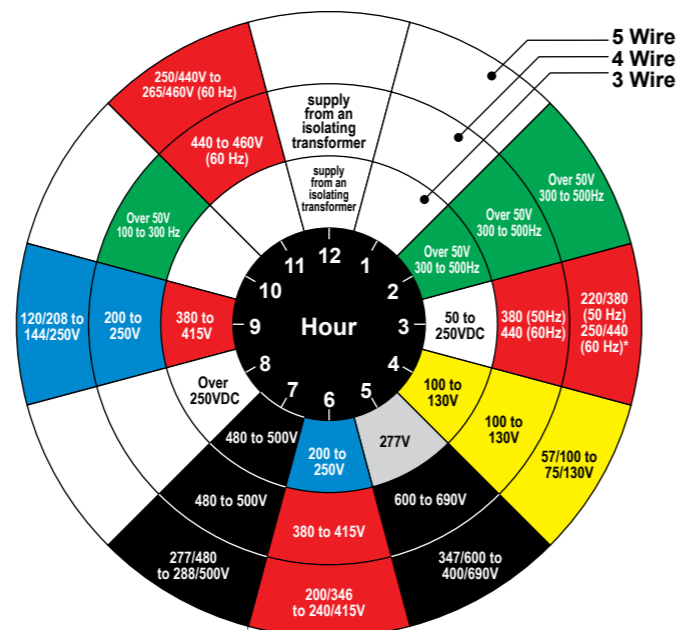

**PIN & SLEEVE
SOCKET LOCKOUT**



PIN & SLEEVE SOCKET LOCKOUT | POLES | A | TENSION | H

Ø 44 mm

RSG - P&S - SL - S	Small			
	2P+T	16	110+130 V	4
3P+T	16	110+130 V	4	
2P+T	32	110+130 V	4	
3P+T	32	110+130 V	4	
2P+T	64	110+130 V	4	
3P+T	64	110+130 V	4	

Ø 55 mm

RSG - P&S - SL - M	Medium			
	2P+T	16	220÷240 V	6
3P+T	16	220÷240 V	9	
3P+N+T	16	220÷240 V	9	
2P+T	32	220÷240 V	6	
3P+T	32	220÷240 V	9	
2P+T	63	220÷240 V	6	
3P+T	63	220÷240 V	9	

Ø 62 mm

RSG - P&S - SL - L	Large			
	3P+T	16	380÷415 V	6
3P+N+T	16	380÷415 V	6	
3P+T	32	380÷415 V	6	
3P+N+T	32	380÷415 V	6	
3P+T	63	380÷415 V	6	
3P+N+T	63	380÷415 V	6	
3P+T	32	380÷415 V	3	

Ø 69 mm

RSG - P&S - SL - XL	Extra Large			
	3P+T	16	500 V	7
3P+N+T	16	500 V	7	
3P+T	32	500 V	7	
3P+N+T	32	500 V	7	
3P+T	63	500 V	7	
3P+N+T	63	500 V	7	

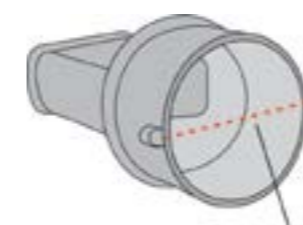

Ø - Outer Dia

MODEL	PRODUCT DESCRIPTION	Outer Dia in mm(Ø)
RSG - P&S - SL - S	Pin & Sleeve Socket Lockout - Small	44
RSG - P&S - SL - M	Pin & Sleeve Socket Lockout - Medium	55
RSG - P&S - SL - L	Pin & Sleeve Socket Lockout - Large	62
RSG - P&S - SL - XL	Pin & Sleeve Socket Lockout - Extra Large	69

**PIN & SLEEVE
SOCKET LOCKOUT**

RSG - P&S - PL: This device is attached to the outer circular wall of the MALE PLUG and it holds the protruded portion of the plug wall. Hence, disallowing the plug to be inserted in the socket.

One product for all sizes of plugs.



Lockout Point



RSG - P&S - PL



MODEL	PRODUCT DESCRIPTION
RSG - P&S - PL	Pin & Sleeve Plug Lockout



As per OSHA, all energy sources should be turned off and locked out to protect employees from injuries caused by the accidental startup of equipment under repair and service. To aid in complying with OSHA 1910.147, we offer a complete range of high quality, universal Circuit Breaker Lockout Devices to ensure that electrical energy sources are isolated for optimal work place safety. These Circuit Breaker Lockouts are part of an extensive line of innovative safety devices designed by professionals to protect employees from risks associated with hazardous energy, while meeting safety and regulatory requirements.

CIRCUIT BREAKER LOCKOUT

MINIATURE CIRCUIT BREAKER LOCKOUT

- Safe & Effective method for locking out Miniature Circuit Breakers.
- Push Button / Slider type MCBL - does not require any tool for installation.
- The Tie Bar style lockout has a convenient thumb wheel for quick application on multiple breakers.
- Can be applied on single / multiple breakers.
- A Padlock should be applied on these lockout devices.

The first three devices in each range work by engaging wire pins into small holes located on either side of the MCB switch toggle. In order to engage the pins into the holes, they have to be exposed further. On the Conventional Type, this is achieved by pressing the spring loaded black plunger with the thumb. On the Premier Type, the two halves of the lockout device hinge apart. In the Slider Type the upper part of CBL is pulled back for releasing the pins & pushed back for locking purpose.

The Tie Bar & MCBL offers a degree of universality. Both can be used on multi-pole breakers which are operated with a tie-bar. MCBL is fixed to the breaker using a small screw driver.

CONVENTIONAL	PREMIER	SLIDER
 RSG - PIN IN CBL	 RSG - PIN IN PCBL	 RSG - PIN IN SCBL
 RSG - PIN OUT CBL	 RSG - PIN OUT PCBL	 RSG - PIN OUT SCBL
 RSG - PIN OUT WIDE CBL	 RSG - PIN OUT WIDE PCBL	 RSG - PIN OUT WIDE SCBL
 RSG - TIE BAR CBL	 RSG - MCBL - R	 RSG - MCBL - Y

*In case Conventional, Premier or Slider CBL are not usable on Circuit Breakers, installed individually/together/ multi-pole, etc. Use our RSG - UMCBL - GT (Universal Miniature Circuit Breaker Lockout - Grip Type).



CIRCUIT BREAKER LOCKOUT



MODEL	PRODUCT DESCRIPTION
RSG - PIN IN CBL	PIN IN Conventional Circuit Breaker Lockout
RSG - PIN OUT CBL	PIN OUT Conventional Circuit Breaker Lockout
RSG - OUT WIDE CBL	PIN OUT WIDE Conventional Circuit Breaker Lockout
RSG - TIE BAR CBL	TIE BAR Conventional Circuit Breaker Lockout
RSG - COMBO CBL	1 Piece each of PI / PO / POW Conventional CBL
RSG - COMBO CBL 4	1 Piece each of all the Conventional CBL



MODEL	PRODUCT DESCRIPTION
RSG - PIN IN PCBL	PIN IN Premier Circuit Breaker Lockout
RSG - PIN OUT PCBL	PIN OUT Premier Circuit Breaker Lockout
RSG - OUT WIDE PCBL	PIN OUT WIDE Premier Circuit Breaker Lockout
RSG - MCBL - R	Miniature Circuit Breaker Lockout - Red
RSG - COMBO PCBL 4	1 Piece each of all the Premier CBL & MCBL - R



MODEL	PRODUCT DESCRIPTION
RSG - PIN IN SCBL	PIN IN Slider Circuit Breaker Lockout
RSG - PIN OUT SCBL	PIN OUT Slider Circuit Breaker Lockout
RSG - PIN OUT WIDE SCBL	PIN OUT WIDE Slider Circuit Breaker Lockout
RSG - MCBL - Y	Miniature Circuit Breaker Lockout - Yellow
RSG - COMBO SCBL 4	1 Piece each of all the Slider CBL & MCBL - Y



MODEL	PRODUCT DESCRIPTION
RSG - UMCBL - GT	Universal Miniature Circuit Breaker Lockout - Grip Type



CIRCUIT BREAKER LOCKOUT

COMBO 5 CIRCUIT BREAKER LOCKOUT

- Safe & effective method for locking out Miniature Circuit Breakers.
- These lockouts can easily be installed with the aid of a screw driver.
- The Brass pherol gives extra life and strength to all the PVC made lockouts & strengthens the grip of internal screw.
- They can be used on single & multi - pole breakers.
- A padlock should be applied on them to lockout the MCBs.



RSG - ULCBL

RSG - UMCBL - GT

RSG - MCBL - Y

RSG - UMCBL - B

RSG - MCBL - GS



MODEL	PRODUCT DESCRIPTION
RSG - MCBL - Y	Miniature Circuit Breaker Lockout - Yellow
RSG - MCBL - GS	Miniature Circuit Breaker Lockout - Green Siemens
RSG - UMCBL - B	Universal Miniature Circuit Breaker Lockout - Blue
RSG - UMCBL - GT	Universal Miniature Circuit Breaker Lockout - Grip Type
RSG - ULCBL	Universal Large Circuit Breaker Lockout - Big Size
RSG - COMBO 5	Combo Miniature Circuit Breaker Lockout (Set of 5)

CIRCUIT BREAKER LOCKOUT

UNIVERSAL CIRCUIT BREAKER LOCKOUT

- Safe & effective method for locking out Circuit Breakers (MCB's & MCCB's).
- These lockout devices can easily be installed with the aid of a screw driver or with the help of Twister Screw. (Standard Pointed Type)
- It can be used on single & multi - pole breakers.
- A padlock on UBL should be applied to lockout the MCBs.



A

B

C

D

RSG - UBL





RSG - UBL - A TS

RSG - UBL - B TS

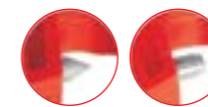

Label for UBL - C & D



 **Pointed & Flat Screws** are available for these Circuit Breaker Lockouts. Kindly mention at the time of ordering.

 Brass threaded insert is used for smooth operation of screw.



RSG - UMPCBL

RSG - MPCBL is specially designed for multi - pole breakers.

MODEL	PRODUCT DESCRIPTION
RSG - UBL	Universal Circuit Breaker Lockout (A/B/C/D) - Order Individually
RSG - UBL COMBO	UBL : set of one each of A, B, C & D
RSG - UBL - A TS	UBL : A Tail Type with Twister Screw
RSG - UBL - B TS	UBL : B Type with Twister Screw
RSG - MPCBL	Multi-Pole Circuit Breaker Lockout

CIRCUIT BREAKER LOCKOUT

TWISTER SCREW MINIATURE CIRCUIT BREAKER LOCKOUT



- Safe & effective method for locking out Miniature Circuit Breakers without a screw driver.
- They can be used on single & multi - pole breakers.
- A padlock should be applied on them to lockout the MCBs.



MODEL	PRODUCT DESCRIPTION
RSG - MCBL - Y TS	Miniature Circuit Breaker Lockout - Yellow with Twister Screw
RSG - MCBL - YU TS	Miniature Circuit Breaker Lockout - Yellow Universal with Twister Screw
RSG - MCBL - YS TS	Miniature Circuit Breaker Lockout - Yellow Siemens with Twister Screw

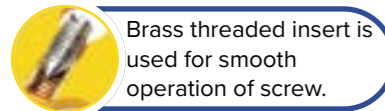

EUROPA MINIATURE CIRCUIT BREAKER LOCKOUT

Nylon MCB Lock, the Europa MCB lock fits most modern breakers. Locks MCBs, RCBOs, RCCBs, and Main switch Isolator, Merlin Gerin MG 26970 for C60 miniature circuit breaker in the ON or OFF Positions. The device has wire clips which engage behind the toggle of the circuit breaker. Once fitted the padlocking device can be secured in place with a safety padlock (not included).

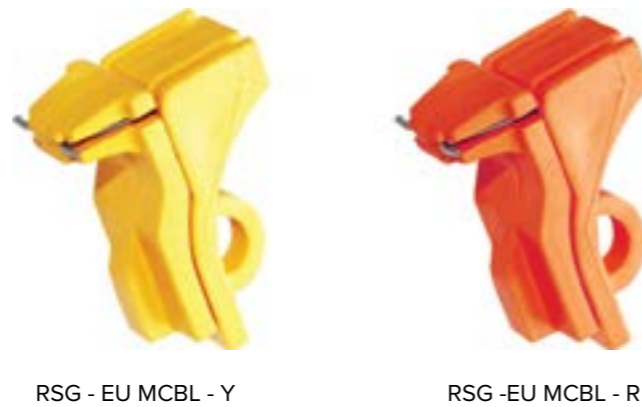

MODEL	PRODUCT DESCRIPTION
RSG - EU MCBL - Y	Europa Miniature Circuit Breaker Lockout - Yellow
RSG - EU MCBL - R	Europa Miniature Circuit Breaker Lockout - Red

CIRCUIT BREAKER LOCKOUT

CLAMP ON BREAKER LOCKOUT



- Extremely versatile - works on wide range of single-pole and internal-trip multi-pole breakers.
- Three sizes available, for 120 / 277 V breakers & for 480 / 600 V. The large lockout fits on breaker switches up to 21 / 4" wide and 7 / 8" thick.
- Made of rugged polypropylene and impact modified nylon.
- Use twister screw to clamp lockout securely onto switch tongue, then pull cover over thumbscrew and lock in place to prevent clamp from being loosened.
- Detachable cleats (included) expand the range of applicable breakers.
- Accepts locks shackles up to 9 mm in diameter.



RSG - COBL - L



MODEL	PRODUCT DESCRIPTION
RSG - COBL - S	Clamp On Breaker Lockout - Small for 120 / 277 V breakers
RSG - C / COBL - S	Cleat for Small Clamp On Breaker Lockout
RSG - COBL - M	COBL - Medium for 480 / 600 V breakers
RSG - C / COBL - M	Cleat for Medium Clamp On Breaker Lockout
RSG - COBL - L	COBL - Large fits on breaker switches up to 21 / 4" wide and 7 / 8" thick
RSG - COMBO COBL	1 Piece each of all the COBL (Small, Medium & Large) + 2 Cleats

CIRCUIT BREAKER LOCKOUT

LARGE CIRCUIT BREAKER LOCKOUT



- Locks out a wide range of three phase Circuit Breakers (227 V & above).
- Fits on lever of Circuit Breaker upto 3" wide & 0.9" thick.
- Handy Device : makes it easy to secure the Large Circuit Breakers at any workplace.
- Rugged Stainless Steel / PVC Constructions.
- Corrosion resistant.
- Easy installation - simply turn the screw into the circuit breaker handle & add your own Padlock & Tag after fitting it properly.



RSG - LCB



RSG - LCB - TS



RSG - LCB - R

MODEL	PRODUCT DESCRIPTION
RSG - LCB	Large Circuit Breaker Lockout
RSG - LCB - TS	LCB - with Twister Screw
RSG - LCB R	LCB - Round Handle

Brass threaded insert is used for smooth operation of screw.

CIRCUIT BREAKER LOCKOUT

TOOL FREE - CIRCUIT BREAKER LOCKOUT



Brass threaded insert is used for smooth operation of screw.

- Specially designed to be used on electrical MCBs & MCCBs.
- Fixation with a thumb twister screw for fast and easy installation.
- Special construction in thermoplastic material resistant to chemicals.
- Withstand extreme environmental conditions.
- Locks off, most of the miniature ISO / DIN circuit breakers.
- Since twister screw is hidden under the cover, it prevents removal of TF CBL.
- Safety padlock / lockout hasps of up to 6 mm can be applied horizontally or vertically.
- **Both pointed & flat screws are supplied with each piece.**



RSG - TF CBL



RSG -TF UCBL

MODEL	PRODUCT DESCRIPTION
RSG - TF CBL	Tool Free Circuit Breaker Lockout
RSG - TF UCBL	Tool Free Universal Circuit Breaker Lockout
RSG - TF COMBO	Combo - Tool Free Circuit Breaker Lockout (Set of 2 - one each)



TOOL FREE - CIRCUIT BREAKER LOCKOUT



Brass threaded insert is used for smooth operation of screw.

- Small one fits standard height and tie-bar toggles typically found on 120 and 240 volt breakers & bigger one fits on wide / tall breaker toggles typically found on hi-voltage / hi-ampere breakers.
- Universal fit exclusive design accommodates many styles of breaker toggles.
- Adjust to breaker with simple thumb turn and then close clamping handle for a tight grip on the toggle, Secure mounting for a solid lockout.
- Compact design, the narrow profile permits side-by-side breaker lockout. These compact devices are also easy to carry and easy to store.
- Durable construction, The Grip Tight lockouts are made of reinforced polymer to operate in harsh conditions.



RSG - GT CBL - S

RSG - GT CBL - L

MODEL	PRODUCT DESCRIPTION
RSG - GT CBL - S	Grip Tight Circuit Breaker Lockout - Small
RSG - GT CBL - L	Grip Tight Circuit Breaker Lockout - Large
RSG - COMBO GT CBL	1 Piece each of GT CBL - S & L

CIRCUIT BREAKER LOCKOUT

LARGE CIRCUIT BREAKER LOCKOUT



RSG - TS - SPBL



RSG - MPBL



RSG - SPL



RSG - DPL - L



RSG - UMP BL

RSG - TS - SPBL: This lockout fits right into the switch. Mount in place over "off" position switch and secure with a padlock. Fits most major brand, single-pole breakers.

RSG - MPBL: Circuit breaker for voltage 120 / 277, requires the breakers to be connected with a cross bar.

RSG - SPL: A single pole lockout that does not require a switch breaker with a recessed hole in it. Circuit breaker lockouts are made of durable polycarbonate material and are quick and easy to apply. "No Hole" Circuit Breaker Lockout is designed to fit circuit breaker toggles up to 1/2" wide without a recess hole in the toggle.

RSG - DPL - L: A double pole lockout, similar to MPBL but slightly larger to accommodate larger breakers. This circuit breaker lockout is now available for either single or double pole circuit breaker lockout applications.

RSG - UMP BL: This clamp-on type circuit breaker lockout is a single device that can be used with most major multi-pole breakers that employ a tie bar. Easy to use, it is made from durable glass-filled nylon with a stainless steel screw. This versatile device is compatible with most of the branded manufacturers, such as GE, ITE, Sylvania, Cutler-Hammer, Challenger, Bryant, Siemens, Square D and General Switch Company. 120/ 277 VOLTS.

To use, just secure the clamp lockout over the tie bar by tightening the thumbscrew and insert padlock to prevent the clamp from being loosened.

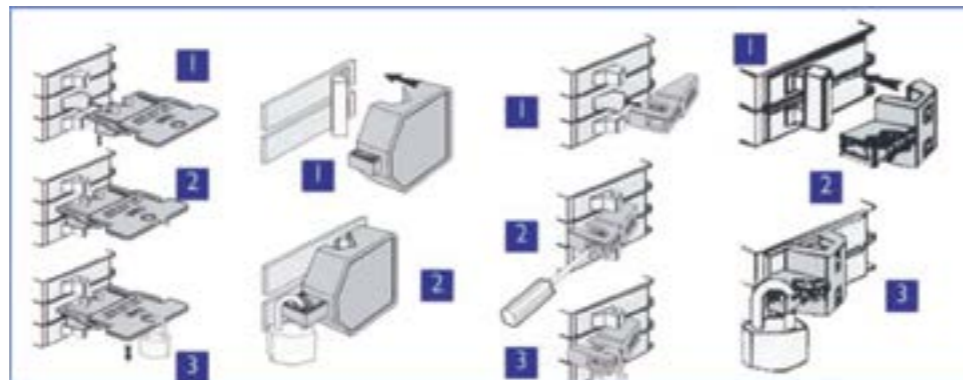

MODEL	PRODUCT DESCRIPTION
RSG - TS - SPBL	Top Slide - Single Pole Breaker Lockout
RSG - MPBL	Multi Pole Breaker Lockout
RSG - SPL	Single Pole Lockout
RSG - DPL - L	Double Pole Lockout for Larger Breakers
RSG - UMP BL	Universal Multi Pole Breaker Lockout

CIRCUIT BREAKER LOCKOUT

UNIVERSAL GOLDEN TOGGLE MCB LOCKOUT



RSG - UGT - MCBL



- Possibly the simplest yet most versatile MCB lockout in our range.
- The GOLDEN TOGGLE LOCK fits over most of the MCB switch toggles and is secured in place using a small flat blade screwdriver to turn the grub screw.
- Once tight & secure, insert your Padlock / Hasp that blocks access to the grub screw, so that the device could not be removed until the lock is removed.
- Works perfectly even where PIN IN / PIN OUT / PINOUT WIDE CBL fails.

MODEL	PRODUCT DESCRIPTION
RSG - UGT - MCBL	Universal Golden Toggle - Miniature Circuit Breaker Lockout

UNIVERSAL MULTI-FUNCTIONAL CIRCUIT BREAKER LOCKOUT



RSG - UMF CBL



- Designed to fit most MCBs and main switches. Our UMF CBL is ideal for use on domestic and industrial applications.
- Extra length clearance on the toggle side allows the device to be used on breakers with extra long toggles, as well as the standard size.
- Thicker main switches are accommodated on the opposite side making this 2-in-1 device truly multi-functional in today's market.

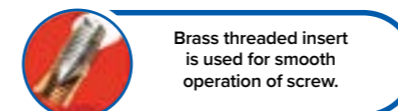

Brass threaded insert is used for smooth operation of screw.

MODEL	PRODUCT DESCRIPTION
RSG - UMF - CBL	Universal Multi Functional - Circuit Breaker Lockout

CIRCUIT BREAKER LOCKOUT

SNAP-ON CIRCUIT BREAKER LOCKOUT

- Designed for 120V breakers that have holes in the switch tongue.
- Quick and easy - just snap in place and apply lock.
- Dual cavities accommodate different size switch tongues.
- RSG - SPBL - GT is also known as universal Breaker Lockout in USA.



RSG - SOCBL



RSG - SOCBL - P

MODEL	PRODUCT DESCRIPTION
RSG - SOCBL	Snap-On Circuit Breaker Lockout
RSG - SOCBL - P	Snap-On Circuit Breaker Lockout - Premier



Brass threaded insert is used for smooth operation of screw.

WALL SWITCH LOCKOUT

- Device to be used to lockout wall-mounted switches.
- Easy to install using existing screws.
- High visibility red color.
- Locks switch in "on" or "off" position.
- Clear poly carbonate lockout uses existing wall plate screws to mount.
- Hinge & Non-hinge pattern.



RSG - WSL - SH

RSG - WSL - TH

RSG - WSL - C

RSG - UWSL

MODEL	PRODUCT DESCRIPTION
RSG - WSL - SH	Wall Switch Lockout - Side Hinge
RSG - WSL - TH	Wall Switch Lockout - Top Hinge
RSG - WSL - C	Wall Switch Lockout - Clear
RSG - UWSL	Universal Wall Switch Lockout

CIRCUIT BREAKER LOCKOUT

TWO WAY BLACK MG TOGGLE HASP

- Two way Merlin Gerin Padlocking Hasp.
- Merlin Gerin Powerpact 4c Toggle Padlocking Attachment.
- This device engages in the slot behind the switch toggle, blocking its operation. Adding a padlock prevents unauthorised operation and secures the device in place when the breaker is in the OFF position.



RSG - TW TH

Installed easily in 3 - steps

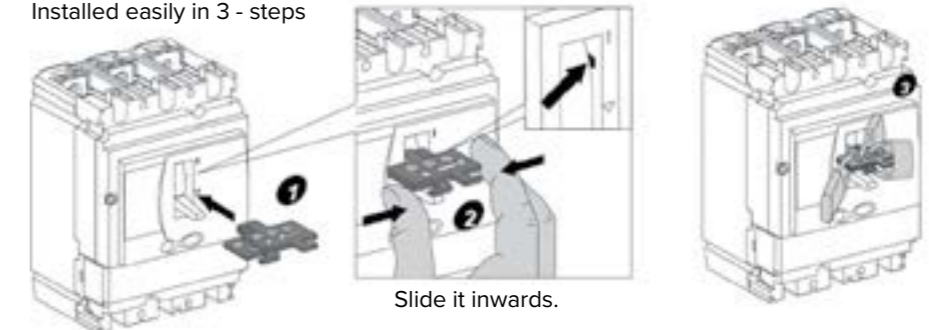

Switch of the MCCB & Insert the "TOGGLE HASP".

Slide it inwards.

Place the Locks in the matching holes.

MODEL	PRODUCT DESCRIPTION
RSG - TW TH	Two Way Black MG Toggle Hasp

MOLDED CASE CIRCUIT BREAKER LOCKOUT

- This is applied to the T1 - T2 - T3 / FUJI molded case circuit breaker cover to prevent the lever closing or opening operation. It allows installation up to a maximum of three padlocks of around 7 mm shackle dia.
- Plug-in locking device only for the closing operation.



RSG - MCCBL - A

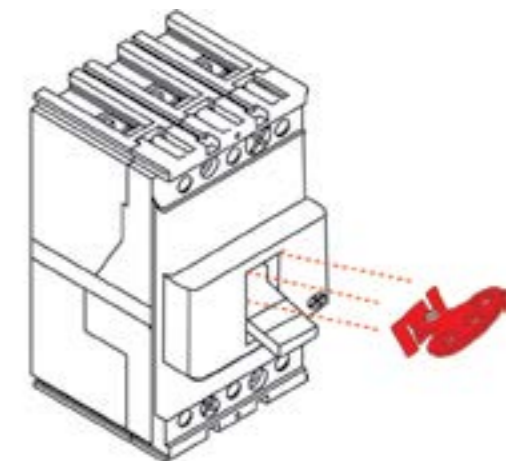

MODEL	PRODUCT DESCRIPTION
RSG - MCCBL - A	Molded Case Circuit Breaker Lockout for ABB

CIRCUIT BREAKER LOCKOUT

ABB CIRCUIT BREAKER LOCKOUT

Locking device for RCCBs
For securing single or multi-pole RCCBs against unauthorised switching on or off. Install direct padlock or use 3 / 6 mm de-electric hasp.

MODEL	PRODUCT DESCRIPTION
RSG - ABB CBL	Snap-On Circuit Breaker Lockout



RSG - ABB CBL

COMPUTER/POWER CORD LOCKOUT



- Handy Device of rugged Stainless Steel /PVC / Nylon construction.
- Corrosion resistant lockout for equipments fitted with the IEC 60320 type input power connector. It fits on most computers, test instruments, power supplies, monitors, lab equipment etc., that use a removable power cord.
- This palm-sized, lightweight, simple device accommodates a personal padlock for lockout / security applications.
- It prevents the insertion of power cords into machinery that utilize IEC 60320 input power connectors.



RSG - CPCL

MODEL	PRODUCT DESCRIPTION
RSG - CPCL	Computer Power Cord Lockout

- Made from clear flexible LD granules.
- Self stick
- Long lasting operation
- Used for hanging small lockout devices on the panel doors.



RSG - HCBL



MODEL	PRODUCT DESCRIPTION
RSG - HCBL	Hanger for Circuit Breaker Lockout

BLOCKING BAR LOCKOUT



For the first time in the world Blocking Bar Lockouts for the computerized digital panels of machines are being made by RSG - New Delhi, India. it helps in restricting the access to the touch buttons on the screen of the electrical panels so that they can not be operated under any circumstances.

BLOCKING BAR LOCKOUT

BLOCKING BAR LOCKOUT

- Lockout your oversized & irregularly shaped switches with our BBL: Blocking Bar Lockout.
- Self-adhesive bases are permanently installed on electrical panels / switches directly.
- Simply clean panel surface and adhere; No drilling required.
- Red blocking bar indicates locked off, green bar indicates locked on.



BLOCKING BAR LOCKOUT

Now you can protect your control panel from unnecessary fiddling and lock them with the help of Blocking Bar Lockout kits.



RSG - 2B FB

RSG - 2B TKB

RSG - 7B TKB



RSG - 4 BG



RSG - 4 BR



RSG - BLH



RSG - 8 BG



RSG - 8 BR



RSG - CB 38



RSG - SB 2 x 2



RSG - CB 75

MODEL	PRODUCT DESCRIPTION
RSG - 2B FB	2B Flat Base
RSG - 2B TKB	2B Thick Base
RSG - 7B TKB	7B Thick Base
RSG - 4 BG	4 - inch Bar Green
RSG - 8 BG	8 - inch Bar Green
RSG - 4 BR	4 - inch Bar Red
RSG - 8 BR	8 - inch Bar Red
RSG - BLH	Blocker Hanger
RSG - CB 38	Circular Blocker 38 mm dia
RSG - CB 75	Circular Blocker 75 mm dia
RSG - SB 2 x 2	Square Blocker 2 x 2 - inch
RSG - RB 3 x 4	Rectangular Blocker 3 x 4 - inch



**BLOCKING BAR
LOCKOUT KIT**



RSG - BBL 5 FT



RSG - BBL 5 TK

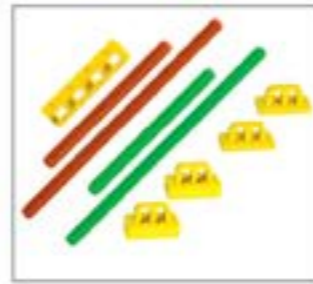

RSG - BBL KT 9



RSG - BBL 5 7BTK



RSG - BBL C 38



RSG - BBL C 75



RSG - BBL S 22



RSG - BBL R 34



RSG - BBL KT 14



Before



After

MODEL	PRODUCT DESCRIPTION
RSG - BBL 5 FT	Blocking Bar Lockout Kit - Flat
RSG - BBL 5 TK	Blocking Bar Lockout Kit - Thick
RSG - BBL KT 9	Blocking Bar Lockout Kit 9
RSG - BBL 5 7BTK	Blocking Bar Lockout Kit - 7B Thick
RSG - BBL C 38	Blocking Bar Lockout Kit - C 38
RSG - BBL C 75	Blocking Bar Lockout Kit - C 75
RSG - BBL S 22	Blocking Bar Lockout Kit - S 22
RSG - BBL R 34	Blocking Bar Lockout Kit - R 34
RSG - BBL KT 14	Blocking Bar Lockout Kit 14
RSG - BBL COMBO 4	Blocking Bar Lockout Kit - Combo 4



RSG - BBL COMBO 4



These Round Fuse Holder Lockouts protect people working on current circuits against unauthorised use and inadvertent switching on of power. They are placed into the fuse base by means of a special screwdriver.

ROUND / BOTTLE FUSE HOLDER LOCKOUT

ROUND / BOTTLE FUSE HOLDER LOCKOUT

These Round / Bottle Fuse Holder Lockouts protect people working on current circuits against unauthorised use and inadvertent switching on of power. They are placed into the fuse base by means of a special screwdriver.

These non-conductive, red color lockouts withstand temperature range: 4°C to +121 °C. They are being made of ABS, PC & Steel / Brass components.

Suitable for:

RSG - RFHL 2: DII / KII fuseholder (E27)

RSG - RFHL 3: DIII / KIII fuseholder (E33)

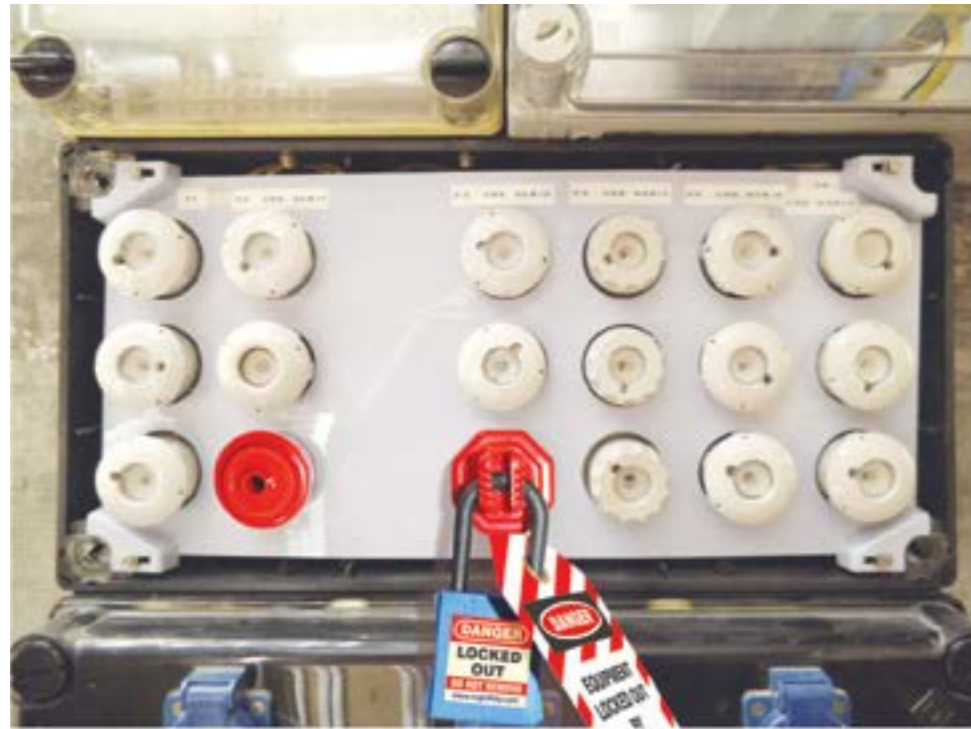

RSG - RFHL 2 RSG - RFHL 3
Round / Bottle Fuse Holder Lockout



RSG - RFHD 2 RSG - RFHD 3
Round / Bottle Fuse Holder Dummies

MODEL	PRODUCT DESCRIPTION
RSG - RFHL 2	Round Fuse Holder Lockout - DII
RSG - RFHL 3	Round Fuse Holder Lockout - DIII
RSG - OT - RFHL	Operating Tool for RFHL
RSG - RFHL KIT	Set of RFHL 2, 3 & OT - RFHL
RSG - RFHD 2	Round Fuse Holder Dummy - DII
RSG - RFHD 3	Round Fuse Holder Dummy - DIII
RSG - OT - RFHD	Operating Tool for RFHD
RSG - RFHD KIT	Set of RFHD 2, 3 & OT - RFHD



Operating Tool for RFHL / RFHD

UNIVERSAL FUSE HOLDER LOCKOUT

- Universal Lockout Device can help prevent un-intended energization of energy source.
- Clamp UFHL onto the fuse holder using a small screwdriver.
- Place a padlock through the hole to prevent access to the set screw.
- One size locks out - Fuse Holders from 20 A to 400 A.
- Nylon Plastic with ZP Metal Set screw.
- By using the **FHL- T & W**, fuse carriers can be locked off.



RSG - UFHL



RSG - UFHL - S



RSG - FHL - WGT



RSG - FHL - TGT



MODEL	PRODUCT DESCRIPTION
RSG - UFHL	Universal Fuse Holder Lockout - Red
RSG - UFHL - S	Universal Fuse Holder Lockout - Slim
RSG - FHL - TGT	Fuse Holder Lockout - Thin Grip Type
RSG - FHL - WGT	Fuse Holder Lockout - Wide Grip Type



Brass threaded insert is used for smooth operation of screw.

PREMIER FUSE HOLDER LOCKOUT

- With the help of screw driver - turn screw for easy installation. Internal screw is inaccessible in the locked position to prevent removal.
- Adjustable design locks out most fuse holders.
- Constructed from ABS for durability.
- Rubberised side pads offer a secure & friction free fitting.
- Can be mounted side-by-side on adjacent fuse holders.



RSG - PFHL

MODEL	PRODUCT DESCRIPTION
RSG - PFHL	Premier Fuse Holder Lockout

FUSE BLOCKER

- Designed to be placed where fuses have been removed to prevent accidental re-insertion of fuses, these unique fuse blocker have the facility to carry a safety tag giving clear identification / instruction.
- Use 4 way blocker to fit fuses 1/4", 9/32", 13/32" & 9/16" in size.
- Use 2 way blocker to fit 13/16", 11/16" & blade type fuses.



RSG - FB - 4W

RSG - FB - 2W

MODEL	PRODUCT DESCRIPTION
RSG - FB - 4W	Fuse Blocker - 4 Way
RSG - FB - 2W	Fuse Blocker - 2 Way

FUSE BLOCKER

- Puller (Medium) for 0 - 100A / 250 Volt & 600 Volt 1/2" to 1" diameter fuses.
- 7.5" long, Convenient and handy for replacing or removing cartridge-type fuses.
- Easily handle fuses from 0 to 600A range.
- High de - electric, fully insulated, glass filled polypropylene construction
- Safe, non-slip notched handles.
- Simple to use, de - electric fuse puller for taking out fuses from the switches before implementing LOTO.



RSG - SGFP

MODEL	PRODUCT DESCRIPTION
RSG - SGFP	Safe Grip Fuse Puller



No matter, what kind of HT / LT, Electrical Panels you have in your facility - We have some or the other lockout device for your Switches, MCBs, MCCBs, Breakers, Isolators, Push Buttons, Emergency Stops, Levers, Panel Door Knobs / Locks, Handles, Fuses, etc.
And if not - We will be glad to create one for you without obligation.
You just have to send us the switch / article for the same.

ELECTRICAL PANEL LOCKOUT

ELECTRICAL PANEL KNOB LOCKOUT

Twisting top cap lockout is used for restricting the access to the electrical panel door locks / knob / screw.

- RSG - EPKL - EL can be installed, where the panel door lock can not be removed.
- RSG - EPKL - BTL can be installed by removing the lock from the panel door and placing the base of LBTL before inserting the lock in the hole and tightening from the back.
- RSG - EP - BSL base is placed at the time of tightening the bakelite screw to the panel door. Twisting top cap is placed for lockout purpose.
- RSG - EP - SL base is placed at the time of tightening the slotted washer head screw to the panel door. Twisting top cap is placed for lockout purpose.



MODEL	PRODUCT DESCRIPTION
RSG - EPKL - EL	Electrical Panel Key Type Lock - Exposed Lockout
RSG - EPKL - BTL	Electrical Panel Key Type Lock - Base Tight Lockout
RSG - EP - BSL	Electrical Panel - Bakelite Screw Type Lockout
RSG - EP - SL	Electrical Panel - Screw Type Lockout

ELECTRICAL PANEL LOCKOUT

LOCKOUT GRIPPER



- Safe & effective method for locking out L & T & other Breakers.
- The lockout can easily be installed with the aid of super strong adhesive backing.
- It can be used for on & off positions.
- In order to lockout the switch a padlock should be applied on the gripper.
- Has 26 x 31 mm space for lever locking.



RSG - GRIPPER

MODEL	PRODUCT DESCRIPTION
RSG - GRIPPER	Lockout Gripper

SLIDER TOGGLE LOCKOUT



This versatile lockout device prevents the accidental activation of large circuit breakers and can work on a wide variety of flip lever style handle switches. It is made of red de - electric ABS plastic, consists of two parts: Mounting base & Slider bar.

It installs quickly and easily with rivets or screws; installed after drilling hole in the panel body.

Mounting base has a dia of 2" and slide bar measure to 5" long and 1" wide with a provision for providing a lockout padlock.



RSG - STL

MODEL	PRODUCT DESCRIPTION
RSG - STL	Slider Toggle Lockout

ELECTRICAL PANEL LOCKOUT



These LOTO units have been designed to lockout electrical panel buttons and switches with no inbuilt lockout provisions. Available in various different designs, they all work in a 2-stage operation. The base plate should be attached directly onto the electrical panel over the top of the relevant switch using the super strong adhesive Backing/Riveting/Bolting. When in place, the electrical plugs/switches/buttons can be isolated by placing the house unit over the top of base plate - hence preventing the access to the isolated switch. Then, they can be locked in place with a Lockout Padlock. The circular units are designed to fit over most of the universal type push / mushroom panel buttons and the square units are designed for the switches with levers. For the switches with extended handles - we have the special patented lockout solutions that freeze the movement of these switches to a still position where they need to be locked at a specific angle.

- ★ This complete range of products can be cut from any side/direction to suit the installation on different panels with varied wiring/attachments to the switches/conduits, levers protruding out or of different shapes.

Manufactured from sturdy special grade transparent material, each unit has been developed to completely enclose electrical plugs to prevent machines from being energized. The plug completely sits inside the unit.

- ★ If more than one unit on a single panel needs to be locked out - we recommend the use of our De Electric Squeezer lockout (RSG - SMCL - YB) with the yellow cable being fed through the access holes of these electrical lockouts and locked at one location by multiple users.



Customization accepted

ELECTRICAL PANEL LOCKOUT



RSG - CIR - 45

RSG - CIR S - 45

RSG - CIR - 55

RSG - CIR S - 55



RSG - SQ S



RSG - SQ B



RSG - SQ B - 45E

RSG - SQ B - L are also available with 45 / 90 degree cutout.

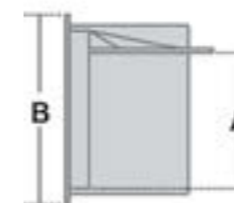

RSG - SQ B - 90E



RSG - SQ B - L

MODEL	PRODUCT DESCRIPTION
RSG - CIR - 45	Electrical Panel Lockout - Round 45
RSG - CIR S - 45	Electrical Panel Lockout - Round 45 Slim
RSG - CIR - 55	Electrical Panel Lockout - Round 55
RSG - CIR S - 55	Electrical Panel Lockout - Round 55 Slim
RSG - SQ S	Electrical Panel Lockout - Square Box - Small
RSG - SQ B	Electrical Panel Lockout - Square Box - Big
RSG - SQ B - 45E	Electrical Panel Lockout - Square Box - Big 45°
RSG - SQ B - 90E	Electrical Panel Lockout - Square Box - Big 90°
RSG - SQ B - L	Electrical Panel Lockout - Square Box - Large

MODEL:	RSG -	CIR - 45	CIR S - 45	CIR - 55	CIR S - 55	SQ S	SQ B	SQ B - 45E	SQ B - 90E	SQ B - L
Inside Size - L x B (A)		36 - Dia	36 - Dia	45 - Dia	45 - Dia	46.5 x 50	66 x 74	66 x 74	66 x 74	92 x 100
Base Size - L x B (B)		50 x 50	50 x 50	61 x 61	61 x 61	72 x 72	95 x 95	95 x 95	95 x 95	129 x 129
Cover Size - L x B x H (C)		47 x 45 x 45	47 x 45 x 25	56 x 54 x 46	56 x 54 x 31	62 x 62 x 62	85 x 85 x 62	85 x 85 x 62	85 x 85 x 62	111 x 111 x 95
No. of Padlock Holes		1	1	1	1	2	2	2	2	2

ELECTRICAL PANEL LOCKOUT

FLEXI COCOON: ROTARY SWITCH COVER LOCKOUT



- Prohibits access to a switch or control.
- Fits both 30.5 mm and 22.5 mm diameter switches.
- Clear bases and cover allow visibility of nameplates and labels.
- Horse - shoe shaped retrofit base allows use with raised nameplates and off-center installation to accommodate rotary switch knobs.
- Accommodates buttons up to 50 mm diameter and 45 mm tall.
- Includes one cover, one new install base and one retrofit base with double sided adhesive tape.



RSG - FC BASE



RSG - FC R BASE



RSG - F COCOON

MODEL	PRODUCT DESCRIPTION
RSG - F COCOON	Flexible Cocoon
RSG - FC BASE	Flexible Cocoon Base (Set of 10 nos.)
RSG - FC R BASE	Flexible Cocoon Retrofit Base (Set of 10 nos.)
RSG - FC KIT	1 Piece each of F COCOON, FC BASE & FC R BASE

COCOON: OVERSIZE PUSH BUTTON LOCKOUT



- Most appreciated lockout solution for the Oversize Electrical Push Buttons on the electrical panels or on control stations. Also finds its application on the Special crane / heavy machinery.
- This lockout device can be easily installed in seconds - by just placing it on the Push buttons thus concealing them in a cocoon, hence protecting them from being accidentally energized.
- The two parts are plugged and then locked out with the help of our lockout padlock.
- Inner size of 70 mm x 85 mm height with 30 mm dia hole in center.



RSG - COCOON

MODEL	PRODUCT DESCRIPTION
RSG - COCOON	Oversize Push Button Locko

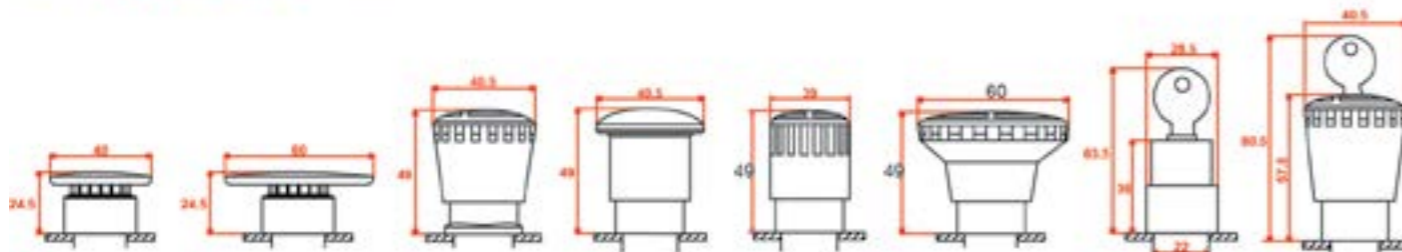

ELECTRICAL PANEL LOCKOUT

ELLIPSE: ELECTRICAL PANEL LOCKOUT



RSG - ELLIPSE

- Safe & effective method for locking out close twin round switches as seen on electrical panels.
- Padlock can be placed for locking / isolating the switches.
- This lockout can be easily installed by just removing the back strip from the double sided super strong backing.
- They are Virtually Transparent.
- 42 x 70 mm inner space.



MODEL	PRODUCT DESCRIPTION
RSG - ELLIPSE	Electrical Panel Lockout - Ellipse

SWITCH COVER LOCKOUT

- Prohibits access to a switch or control.
- Clear bases and cover allow visibility of nameplates and labels.
- Accommodates buttons up to 50 mm diameter and 40 mm tall.



RSG - SCL 23



RSG - SCL 30



RSG - SCLP 9



RSG - SCLP 23



RSG - SCLP 30

MODEL	PRODUCT DESCRIPTION
RSG - SCL 23	Switch Cover Lockout - 23 mm hole dia
RSG - SCL 30	Switch Cover Lockout - 30 mm hole dia
RSG - SCLP 9	Switch Cover Lockout Premier - 9 mm hole dia
RSG - SCLP 23	Switch Cover Lockout Premier - 23 mm hole dia
RSG - SCLP 30	Switch Cover Lockout Premier - 30 mm hole dia

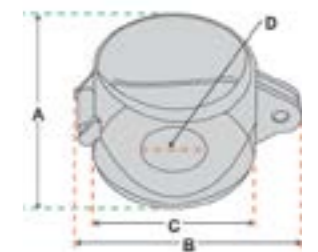

Dimension in mm

MODEL	RSG - SCL 23	RSG - SCL 30	RSG - SCLP 9	RSG - SCLP 23	RSG - SCLP 30
Height (A)	32	32	42	42	42
Width (B)	70	70	78	78	78
Base Size (C)	49	49	54	54	54
Hole Dia (D)	23	30	9	23	30



ELECTRICAL PANEL LOCKOUT

MUSHROOM: NORMAL PUSH BUTTON LOCKOUT



- Safe & effective method of locking out emergency stop type Mushroom buttons of normal sizes.
- Made from clear polycarbonate.
- Supplied with a red beak padlock installer.
- Lockout labels are provided.
- Inner Dia: 33 x 68 mm, Hole Dia: 29 mm



RSG - MUSHROOM

MODEL	PRODUCT DESCRIPTION
RSG - MUSHROOM	Normal push button Lockout for electrical panels

ELECTRICAL PANEL HANDLE LOCKOUT



Patented design of EPHL freezes the movement of the bigger handles / levers installed on the electrical panels. Yellow base and flexible powder coated stainless steel strip of 25 mm x 300 mm with 20 holes makes it impossible for the handles to move from their position once locked with the help of two yellow clamps and a lockout padlock. Best suitable / Recommended for handles and all kinds of levers having no arrangement for lockout.



RSG - EPHL

MODEL	PRODUCT DESCRIPTION
RSG - EPHL	Electrical Panel Handle Lockout
RSG - EPHL - DE	EPHL with De - electric Strip

* Lock shown is not a part of product

EPHL also available with De - Electric Strip

ELECTRICAL PANEL LOCKOUT

ELECTRICAL PANEL HOLE LOCKOUT: STAINLESS STEEL



- This die cut piece is made of Stainless steel sheet and is installed to the panel surface by using soft washer and rivet.
- In the other hand a small / large size padlock eye is used depending on the height of the panel door / installation pattern for lockout purpose.
- Comes with rubber washer, nut and screw + right angled padlock eye.



RSG - EPHOL SS



RSG - EPHOL SS - KIT

MODEL	PRODUCT DESCRIPTION
RSG - EPHOL SS	Electrical Panel Hole Lockout - Stainless Steel
RSG - EPHOL SS - KIT	EPHOL SS - Kit

ELECTRICAL PANEL HOLE LOCKOUT: TWIN LEG



- Three piece lockout made especially for the holes in the electrical panels where the Rack in/out rods are inserted.
- They block the access to the hole and restrict the insertion of the rod for operating the devices inside.
- E-Hasp 33 is recommended with this device for installing the locks on it.
- Suitable for 20 mm hole dia with 29 mm to 39 mm depth.



RSG - EPHOL TL

MODEL	PRODUCT DESCRIPTION
RSG - EPHOL TL	Electrical Panel Hole Lockout - Twin Leg

**ELECTRICAL PANEL
HOLE LOCKOUT:
CIRCULAR**

- Material - Body made of ABS, attached with rivet.
- Round Shape Di-Electric Lockout device is used to lock the racking in - out point of air circuit breaker and vacuum circuit breaker, etc. so that no one could operate the particular device.
- Also used for locking switches that are recessed inside a plane surface.
- Easily rotated in any direction - have three holes on the bottom part for fixing it with the help of screws / rivets.
- It can also be installed to the surface by using the strong double sided tapes.
- Dimension: Outer Diameter is 46 mm, Inner Diameter is 32 mm, lower cover circle side wall thickness is 7 mm, overall thickness is 8 mm with upper part thickness 3 mm and lower part thickness is 5 mm, locking hole diameter is 1 mm.



RSG - EPHOL CR



RSG - EPHOL CY



MODEL	PRODUCT DESCRIPTION
RSG - EPHOL CR	Electrical Panel Hole Lockout - Circular Red
RSG - EPHOL CY	Electrical Panel Hole Lockout - Circular Yellow

**ELECTRICAL PANEL
HOLE LOCKOUT:
ELLIPSE**

- Safe & effective method for locking out electrical panel holes.
- Padlock can be placed for locking / isolating.
- This lockout can be easily installed by just removing the back strip from the double sided super strong backings.
- They are Virtually Transparent.
- 42 x 70 mm inner space.



RSG - EPHOL EL



MODEL	PRODUCT DESCRIPTION
RSG - EPHOL EL	Electrical Panel Hole Lockout - Ellipse



Our Lockout Padlock range give you the physical tools to help you implement and maintain an effective Safety Lockout program as per your own OSHA Policy & Procedures and your own Energy Control Program, to prevent accidents and protect your employees.

Safety Lockout Padlocks are available in range of colors to increase visibility and allow workers to readily see if a device is isolated. Padlock numbering / Metal Tagging, Etching on Shackle, Logo and Department Labels, photographs of employees or employee codes etc. on the personalized locks are also available on request and at an extra cost.

LOCKOUT SAFETY PADLOCK

KEYING OPTIONS

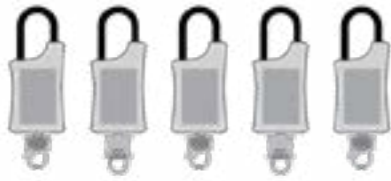

Key Different means that every lock has its individual key and the key for one lock can not open another lock in any case.

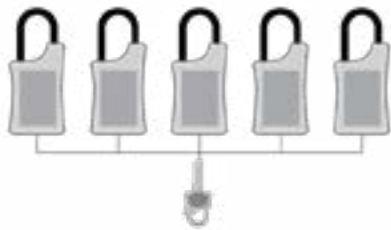

Key Alike means all locks in a set can be opened with the same key.

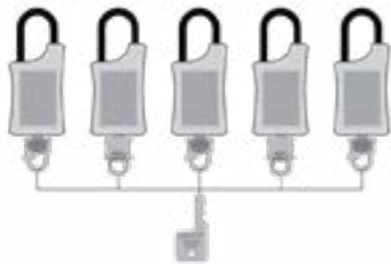

Master Key can be used to open multiple locks that are keyed differently.

OSHA LOCKOUT / TAGOUT REGULATION

1910.147(c)(5) OSHA lockout Device requirements state that lockout devices must:

- Be provided by the employer.
- Be standardized by size, shape or color.
- Be distinguishable from locks used for other purposes. Lockout locks should only be used for lockout.
- Identify the individual who applied the lock (both tags and lock labels are acceptable for this purpose).
- Be capable of withstanding the usage environment and must be strong enough to prevent removal except by using excessive force with special tools, such as bolt cutters.
- Most importantly, whenever lockout devices are applied, they must remain under the exclusive control of the individual who attached them. No employee should be able to open a lock attached by someone else.

Kindly select the padlocks carefully as per your requirements.

- Shackle Type / Shackle Size / Padlock Body Color
- Key Alike (means all the supplied locks have one common key)
- Key Different (means that all the supplied locks can be opened with their respective keys only)
- Key Different + Master Keys (means that all the supplied locks can be opened with their respective keys + with one master key)

Number of extra keys required. They can be supplied against the confirmed order and at an extra cost.

Attention!

Choose the Lock that suits your requirement

MODEL	Compact, Lightweight	Nonconductive body	Corrosion Resistant	Spark Resistant	Keyed Different	Keyed Alike	Keyed Alike available on Locks	Master Keyed	Master Keyed available on Locks
RSG - PRS					✓				
RSG - PLS					✓	✓	100		
RSG - JPRS		✓			✓				
RSG - JPLS		✓			✓	✓	500	✓	25
RSG - PLSP		✓			✓	✓	1000	✓	500
RSG - DEL	✓	✓	✓	✓	✓	✓	1000	✓	500
RSG - HLSP		✓			✓	✓	500	✓	500
RSG - HDEL	✓	✓	✓	✓	✓	✓	500	✓	500

LOCKOUT SAFETY PADLOCK

CABLE LOCKOUT SAFETY PADLOCKS

These cable lock use vinyl coated steel cable for maximum strength and flexibility. The padlock has the standard PLSP lock body.

- Cable are available from 1 feet to 4 feet.
- Customized length orders are also accepted.
- Lock body is available in all the 12 colours.
- Standard colour is **RED**.
- Each lock is supplied with 1 key.



RSG - CLSP - 01



RSG - CLSP - 02



RSG - CLSP - 03



RSG - CLSP - 04

All CLSP Locks are available in:

- > **Key Different**
- > **Key Alike**
- > **Key Different + Master Key**



MODEL	PRODUCT DESCRIPTION
RSG - CLSP - 01	Cable Lockout Safety Padlock with 1 feet cable
RSG - CLSP - 02	Cable Lockout Safety Padlock with 2 feet cable
RSG - CLSP - 03	Cable Lockout Safety Padlock with 3 feet cable
RSG - CLSP - 04	Cable Lockout Safety Padlock with 4 feet cable

LOCKOUT SAFETY PADLOCK

STEEL PADLOCKS - REGULAR & LONG SHACKLE

- Top-Quality Padlocks Offer Enhanced Security Features
- Maximum security laminated padlocks are made for tough lockout situations.
- Shackle is made of a special metal alloy for increased durability against cutting, prying and twisting.
- They have 5-pin tumbler cylinders for additional keying options.
- They are available in Green, Blue, Red, Yellow, Black & Orange colours.
- Other colours are available on request (minimum quantity order applicable).
- **Each lock is supplied with 2 keys.**
- Double locking padlock with an innovative laminated construction to achieve exceptional level of impact resistance.



RSG - PRS 3



RSG - PLS 3



RSG - PRS

RSG - PLS

MODEL	PRODUCT DESCRIPTION
RSG - PRS 3	Padlock with REGULAR Shackle - Set of 3 Nos.
RSG - PRS - KD	Padlock with REGULAR Shackle - Key Different
RSG - PLS 3	Padlock with LONG Shackle - Set of 3 Nos.
RSG - PLS - KD	Padlock with LONG Shackle - Key Different
RSG - PLS - KA	Padlock with LONG Shackle - Key Alike

2 Keys

2 Keys

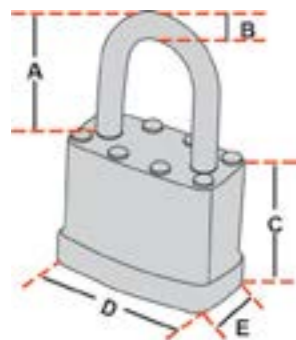

Dimension in mm

MODEL	RSG - PRS	RSG - PLS
Shackle Height (A)	30	54
Shackle Dia (B)	6	6
Body Height (C)	37	37
Body Width (D)	43	43
Body Depth (E)	25	25



MODEL	Keyed Different	Keyed Alike	Keyed Alike available on Locks	Body Type	Shackle Type
RSG - PRS	✓			Steel	Steel
RSG - PLS	✓	✓	100	Steel	Steel

LOCKOUT SAFETY PADLOCK

JACKET PADLOCKS REGULAR & LONG SHACKLE

- A set of three lockout jacket padlocks supplied with injection moulded De electric Blue / Red & Yellow JACKETS.
- Specifically drafted instruction label for each lock is provided.
- Separate locks are also available in different colors (Green / Blue / Red / Yellow / Black & Orange) in any quantity.
- **Each lock is supplied with 3 keys.**
- Available in Regular & Long steel shackles.



RSG - JPRS 3



RSG - JPLS 3



RSG - JPRS

RSG - JPLS

MODEL	PRODUCT DESCRIPTION
RSG - JPRS 3	Jacket Padlock with REGULAR Shackle - Set of 3 Nos.
RSG - JPRS - KD	Jacket Padlock with REGULAR Shackle - Key Different
RSG - JPLS 3	Jacket Padlock with LONG Shackle - Set of 3 Nos.
RSG - JPLS - KD	Jacket Padlock with LONG Shackle - Key Different
RSG - JPLS - KA	Jacket Padlock with LONG Shackle - Key Alike
RSG - JPLS - KD + M	Jacket Padlock with LONG Shackle - Key Different + Master Key

3 Keys

3 Keys

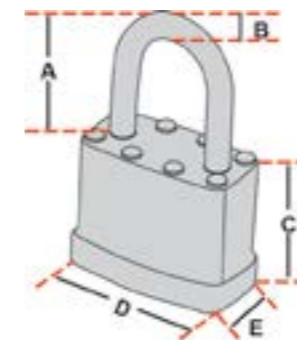

Dimension in mm

MODEL	RSG - JPRS	RSG - JPLS
Shackle Height (A)	17	66
Shackle Dia (B)	6	6
Body Height (C)	46	46
Body Width (D)	43	43
Body Depth (E)	22	22



MODEL	Keyed Different	Keyed Alike	Keyed Alike available on Locks	Master Keyed	Keyed Alike available on Locks	Body Type	Shackle Type
RSG - JPRS	✓					ABS	Steel
RSG - JPLS	✓	✓	500	✓	25	ABS	Steel

LOCKOUT SAFETY PADLOCK

PREMIER LOCKOUT SAFETY PADLOCKS: METALLIC SHACKLE

Compact high security PREMIER LOCKOUT SAFETY PADLOCKS were designed on the basis of the feed back received from more than 2,000 users. The nylon body is carved / designed with ribs for easy gripping and handling. Supplied with an individual unique coded brass key and cylinder to differ 6-pin locking combinations. The Jack locking key mechanism does not allow the release of key, until the shackle is closed and the padlock is locked.

- 6-pin precision-machined cylinder for extra security.
- Re-inforced Nylon body is non-conductive, non-sparking and resistant to chemicals and corrosion.
- Colour coded for easy identification, they can also be supplied with photo luminescent labels that glow in the dark. Supplied with individually coded keys for optimum security.
- **Each padlock is supplied in a box with 1 key.**
- Available in Hardened Steel shackle or with Stainless Steel Shackle (in 25 / 46 / 85 mm shackle sizes) SS shackles are used for corrosive industrial / offshore environments.
- Most popular combination of Master Key locks is of 5 Key Different locks with 1 master key.
- Locks of any size / combination / colour or shackle types can be made & supplied on request.
- Locks with longer size body and with extra large sized shackles are also available in all the combinations & colours.



RSG - PLSP - KD 3C



RSG - PLSP - 25

RSG - PLSP - KD

RSG - PLSP - 85

RSG - PLSP- LB - 46

RSG - PLSP- LB - 85

Normal Body

Long Body

LOCKOUT SAFETY PADLOCK

PREMIER LOCKOUT SAFETY PADLOCKS: METALLIC SHACKLE

MODEL	PLSPadlock with Steel Shackle
RSG - PLSP - 25 - KD	RSG - PLSP - 25 - Key Different
RSG - PLSP - 25 - KA	RSG - PLSP - 25 - Key Alike
RSG - PLSP - 25 - KD + M	RSG - PLSP - 25 - Key Different + Master Key
RSG - PLSP - KD 3C	RSG - PLSP - 46 - Key Different - Set of 3 Colours
RSG - PLSP - KD	RSG - PLSP - 46 - Key Different
RSG - PLSP - KA	RSG - PLSP - 46 - Key Alike
RSG - PLSP - KD + M	RSG - PLSP - 46 - Key Different + Master Key
RSG - PLSP - 85 - KD	RSG - PLSP - 85 - Key Different
RSG - PLSP - 85 - KA	RSG - PLSP - 85 - Key Alike
RSG - PLSP - 85 - KD + M	RSG - PLSP - 85 - Key Different + Master Key
RSG - PLSP - LB - 46 - KD	RSG - PLSP - LB - 46 - Key Different
RSG - PLSP - LB - 46 - KA	RSG - PLSP - LB - 46 - Key Alike
RSG - PLSP - LB - 46 - KD + M	RSG - PLSP - LB - 46 - Key Different + Master Key
RSG - PLSP - LB - 85 - KD	RSG - PLSP - LB - 85 - Key Different
RSG - PLSP - LB - 85 - KA	RSG - PLSP - LB - 85 - Key Alike
RSG - PLSP - LB - 85 - KD + M	RSG - PLSP - LB - 85 - Key Different + Master Key

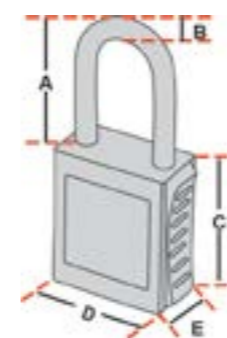

1 Keys



Dimension in mm

MODEL	RSG - PLSP - 25	RSG - PLSP - KD	RS - PLSP - 85 G	RSG - PLSP- LB - 46	RSG - PLSP- LB - 85
Shackle Height (A)	25	46	85	46	85
Shackle Dia (B)	6	6	6	6	6
Body Height (C)	45	45	45	80	80
Body Width (D)	43	43	43	43	43
Body Depth (E)	20	20	20	20	20

All PLSP locks (RSG - PLSP - 25, RSG - PLSP - KD, RSG - PLSP - 85, RSG - PLSP - LB - 46, RSG - PLSP - LB - 85) are available in: Key Different / Key Alike / Key Different + Master Key

MODEL	Keyed Different	Keyed Alike	Keyed Alike available on Locks	Master Keyed	Keyed Alike available on Locks	Body Type	Shackle Type
RSG - PLSP	✓	✓	1000	✓	500	Polyamide Nylon	Steel/SS

LOCKOUT SAFETY PADLOCK

PREMIER LOCKOUT SAFETY PADLOCKS: DE - ELECTRIC SHACKLE

Our De - Electric version of PLSP Locks have hardened **reinforced Nylon Shackle** which are completely non-conductive and ideal for their use on Electrical Panels.

RSG - DEL - KD, RSG - DEL - 85, RSG - DEL - LB - 42, RSG - DEL - LB - 85 are available in:

- Key Different
- Key Alike
- Key Different + Master Key



RSG - DEL - KD 3C



RSG - DEL - KD RSG - DEL - 85 RSG - DEL - LB - 42 RSG - DEL - LB - 85
Normal Body Long Body

MODEL	PLSP De - ELECTRIC Padlock with Nylon Shackle
RSG - DEL - KD 3C	RSG - DEL - 42 - Key Different - Set of 3 Colours
RSG - DEL - KD	RSG - DEL - 42 - Key Different
RSG - DEL - KA	RSG - DEL - 42 - Key Alike
RSG - DEL - KD + M	RSG - DEL - 42 - Key Different + Master Key
RSG - DEL - 85 - KD	RSG - DEL - 85 - Key Different
RSG - DEL - 85 - KA	RSG - DEL - 85 - Key Alike
RSG - DEL - 85 - KD + M	RSG - DEL - 85 - Key Different + Master Key
RSG - DEL - LB - 42 - KD	RSG - DEL - LB - 42 - Key Different
RSG - DEL - LB - 42 - KA	RSG - DEL - LB - 42 - Key Alike
RSG - DEL - LB - 42 - KD + M	RSG - DEL - LB - 42 - Key Different + Master Key
RSG - DEL - LB - 85 - KD	RSG - DEL - LB - 85 - Key Different
RSG - DEL - LB - 85 - KA	RSG - DEL - LB - 85 - Key Alike
RSG - DEL - LB - 85 - KD + M	RSG - DEL - LB - 85 - Key Different + Master Key

Dimension in mm

MODEL	RSG - DEL - KD	RSG - DEL - 85	RSG - DEL - LB - 42	RSG - DEL - LB - 85
Shackle Height (A)	42	85	42	85
Shackle Dia (B)	6	6	6	6
Body Height (C)	45	45	80	80
Body Width (D)	43	43	43	43
Body Depth (E)	20	20	20	20



MODEL	Keyed Different	Keyed Alike	Keyed Alike available on Locks	Master Keyed	Keyed Alike available on Locks	Body Type	Shackle Type
RSG - DEL	✓	✓	1000	✓	500	Polyamide Nylon	Nylon



LOCKOUT SAFETY PADLOCK

CUSTOMIZATION REQUIREMENT

These services are available at an extra cost depending on the work and the time involved.

- Company Name
- Logo
- Plant Location
- Lock No.
- Department Name
- Employee Name
- Employee Photo
- Employee Code No.



Metal tagging + Numbering on shackle

Company Logo, Department Name, Lock Number Label

Personalized Locks



Laser Engraving

Lock number label for different Department - Colored Locks



Lock No. punching at the bottom



Lock number punching on key



Key chains with Company Logo, Department Name, Lock No. etc.



Extra Keys

LOCKOUT SAFETY PADLOCK

HANDY LOCKOUT SAFETY PADLOCKS:

- STEEL
- STAINLESS STEEL
- DE - ELECTRIC NYLON SHACKLES

Compact high security Handy Lockout Safety Padlocks are designed considering different types of users. The nylon body is carved / designed with ribbs for easy gripping and handling. Supplied with an individual unique coded brass key and cylinder to differ 6-pin locking combinations. The Jack locking key mechanism does not allow the release of key, until the shackle is closed and the padlock is locked.



RSG - HLSP - 46 RSG - HLSP - 85 RSG - HDEL - 42 RSG - HDEL - 85



RSG - HLSP - 46 - KD 3C

RSG - HDEL - 42 - KD 3C

LOCKOUT SAFETY PADLOCK

HANDY LOCKOUT SAFETY PADLOCKS:

- STEEL
- STAINLESS STEEL
- DE - ELECTRIC NYLON SHACKLES

MODEL	HLSPadlock with Steel Shackle
RSG - HLSP - 46 - KD 3C	RSG - HLSP - 46 - Key Different - Set of 3 Colours
RSG - HLSP - 46 - KD	RSG - HLSP - 46 - Key Different
RSG - HLSP - 46 - KA	RSG - HLSP - 46 - Key Alike
RSG - HLSP - 46 - KD + M	RSG - HLSP - 46 - Key Different + Master Key
RSG - HLSP - 85 - KD	RSG - HLSP - 85 - Key Different
RSG - HLSP - 85 - KA	RSG - HLSP - 85 - Key Alike
RSG - HLSP - 85 - KD + M	RSG - HLSP - 85 - Key Different + Master Key

MODEL	HLSP De - ELECTRIC Padlock with Nylon Shackle
RSG - DEL - KD 3C	RSG - HDEL - 42 - Key Different - Set of 3 Colours
RSG - DEL - KD	RSG - HDEL - 42 - Key Different
RSG - DEL - KA	RSG - HDEL - 42 - Key Alike
RSG - DEL - KD + M	RSG - HDEL - 42 - Key Different + Master Key
RSG - DEL - 85 - KD	RSG - HDEL - 85 - Key Different
RSG - DEL - 85 - KA	RSG - HDEL - 85 - Key Alike
RSG - DEL - 85 - KD + M	RSG - HDEL - 85 - Key Different + Master Key

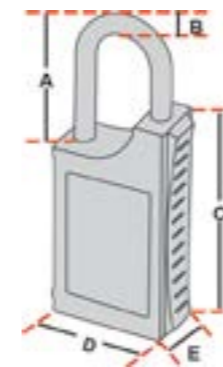

1 Keys

Customization accepted



Dimension in mm

MODEL	RSG - HLSP - 46	RSG - HLSP - 85	RSG - HDEL - 42	RSG - HDEL - 85
Shackle Height (A)	46	85	42	85
Shackle Dia (B)	6	6	6	6
Body Height (C)	73	73	73	73
Body Width (D)	43	43	43	43
Body Depth (E)	20	20	20	20

All PLSP locks (RSG - HLSP - 46, RSG - HLSP - 85, RSG - HDEL - 42, RSG - HDEL - 85) are available in: Key Different / Key Alike / Key Different + Master Key

MODEL	Keyed Different	Keyed Alike	Keyed Alike available on Locks	Master Keyed	Keyed Alike available on Locks	Body Type	Shackle Type
RSG - HLSP	✓	✓	500	✓	500	Polyamide Nylon	Steel/SS
RSG - HDEL	✓	✓	500	✓	500	Polyamide Nylon	Nylon

LOCKOUT SAFETY PADLOCK

STAINLESS STEEL LOCKOUT PADLOCKS

Stainless steel Lockout Padlocks of 40 mm size with stainless steel **6 mm** shackle.

- Corrosion resistant
- Mushroom pins
- Standard section key way
- Pin tumbler locking system
- Stainless steel springs
- **2 nickel plated brass keys**
- **Body Type** - Stainless Steel
- **Shackle Type** - Stainless Steel
- **Key Alike** - Upto set of 100 Nos.
- **Master Key** - Upto set of 5 Nos.



RSG - SSLP - S

RSG - SSLP - L

2 Keys

MODEL	PRODUCT DESCRIPTION
RSG - SSLP - S	Stainless Steel Lockout Padlock - Small
RSG - SSLP - L	Stainless Steel Lockout Padlock - Long



BRASS LOCKOUT PADLOCKS WITH STEEL SHACKLE

- The 40 mm Brass Padlock has solid brass body with a brass cylinder and a spring loaded chrome plated steel shackle.
- Each lock is **supplied with 2 keys** as standard.
- Hardened Steel Shackle of **6 mm** diameter has double locking.
- Hardened shackle resists sawing and filing.
- **Body Type** - Brass
- **Shackle Type** - Steel
- **Key Alike** - Upto set of 200 Nos.
- **Master Key** - Upto set of 5 Nos.



RSG - BPSS - S

RSG - BPSS - L

2 Keys

MODEL	PRODUCT DESCRIPTION
RSG - BPSS - S	Brass Lockout Padlock with Steel Shackle - Small
RSG - BPSS - L	Brass Lockout Padlock with Steel Shackle - Long



Dimension in mm

MODEL	RSG - SSLP - S	RSG - SSLP - L	RSG - BPSS - S	RSG - BPSS - L
Shackle Height (A)	27	74	30	77
Shackle Dia (B)	6	6	6	6
Body Height (C)	35	35	33	33
Body Width (D)	40	40	40	40
Body Depth (E)	15	15	15	15

* Measurement can change without notice.

LOCKOUT SAFETY PADLOCK

COMPLETE BRASS LOCKOUT PADLOCKS

- The 40 mm Brass Padlock has solid brass body with a brass cylinder and a spring loaded brass shackle. Each lock is **supplied with 2 keys** as standard.
- Has Brass Shackle of 5 mm / 6 mm diameter with double locking.
- Brass body and cylinder provide extra resistance to the elements.
- Comes with **key hole cover** and **shackle dust guard**.
- **Body Type** - Brass
- **Shackle Type** - Brass
- **Key Alike** - Upto set of 200 Nos.
- **Key Different + Master Key** - Upto set of 25 Nos.



RSG - CBLP - 5S

RSG - CBLP - 5L

2 Keys

MODEL	PRODUCT DESCRIPTION
RSG - CBLP - 5S	Complete Brass Lockout Padlock - Small with 5 mm Shackle
RSG - CBLP - 5L	Complete Brass Lockout Padlock - Long with 5 mm Shackle
RSG - CBLP - 6S	Complete Brass Lockout Padlock - Small with 6 mm Shackle
RSG - CBLP - 6L	Complete Brass Lockout Padlock - Long with 6 mm Shackle



BRASS COMBINATION LOCKOUT PADLOCKS

- Brass padlock with 3 and 4 side wheel combinations which are suitable for basic protection, barrier and deterrent applications such as locking the MCBs, special switches with small locking holes, small group lock boxes, etc.
- Resettable Combination Brass Padlock.
- Available in 2 different sizes to choose from with **3 mm** shackle.



RSG - BCLP - 3W

RSG - BCLP - 4W

MODEL	PRODUCT DESCRIPTION
RSG - BCLP - 3W	Brass Combination Lockout Padlock - 3 Wheels
RSG - BCLP - 4W	Brass Combination Lockout Padlock - 4 Wheels

Dimension in mm

MODEL	RSG - CBLP - 5S	RSG - CBLP - 5L	RSG - CBLP - 6S	RSG - CBLP - 6L	RSG - BCLP - 3W	RSG - BCLP - 4W
Shackle Height (A)	30	45	32	47	25	25
Shackle Dia (B)	5	5	6	6	3	3
Body Height (C)	36	36	36	36	29	55
Body Width (D)	40	40	40	40	23	23
Body Depth (E)	15	15	15	15	13	13

* Measurement can change without notice.

LOCKOUT SAFETY PADLOCK

WEATHER RESISTANT ENCASED LAMINATED STEEL BODY LOCKOUT PADLOCKS

- The 40 mm Laminated Steel Padlocks with weather resistant casing.
- Hardened steel shackle with molded thermoplastic cover.
- Hardened shackle resists sawing and filing.
- High-tech thermoplastic shell designed to withstand the elements.
- Shackle O-ring and key hole cover seals out moisture and dirt.
- Available in total blank/yellow-black combinations.



MODEL	PRODUCT DESCRIPTION
RSG - WRLP - YB	Weather Resistant - Encased Laminated Steel Body Lockout Padlock - Yellow Black
RSG - WRLP - B	Weather Resistant - Encased Laminated Steel Body Lockout Padlock - Black

ALUMINIUM LOCKOUT PADLOCKS

- The 40 mm Aluminium Padlock has solid aluminium body with a brass cylinder.
- Spring loaded chrome plated hardened 6 mm steel shackle.
- Each lock is supplied with 2 keys as standard.
- Shackle has double locking.
- Hardened shackle resists sawing and filing.



MODEL	PRODUCT DESCRIPTION
RSG - ALP	Aluminium Lockout Padlock with Standard Steel Shackle

Dimension in mm

MODEL	RSG - WRLP - YB	RSG - WRLP - B	RSG - ALP
Shackle Height (A)	50	50	33
Shackle Dia (B)	7	7	6
Body Height (C)	44	44	40
Body Width (D)	51	51	38
Body Depth (E)	31	31	18

 Customization accepted



LOCKOUT SAFETY PADLOCK

PADLOCK LABELS

Use these labels on lockout safely padlocks RSG - JPLS, RSG - JPRS, RSG - PLSP & RSG - PLSP - LB, RSG - DEL & RSG - DEL - LB, RSG - HLSP, RSG - HDEL to clearly instruct workers when a machine is down for service or maintenance.

Padlock Labels for RSG - PLSP & RSG - DEL



RSG - PLSP - S

Padlock Labels for RSG - JPLS, RSG - JPRS

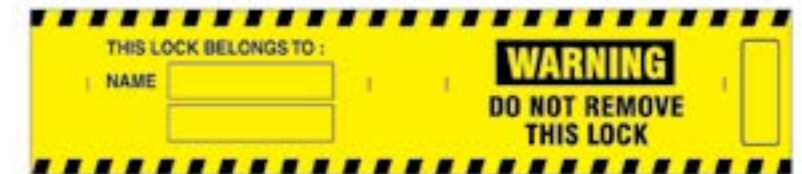

RSG - JPL - 1

Padlock Labels for RSG - PLSP - LB & RSG - DEL - LB



RSG - PLSP - L



RSG - JPL - 2



RSG - JPL - 3

Padlock Labels for RSG - HLSP & RSG - HDEL



RSG - HLSP



RSG - JPL - 4

MODEL	PRODUCT DESCRIPTION
RSG - JPL - 1	Jacket Padlock Label - 1
RSG - JPL - 2	Jacket Padlock Label - 2
RSG - JPL - 3	Jacket Padlock Label - 3
RSG - JPL - 4	Jacket Padlock Label - 4
RSG - PLSP - S	Label for RSG - PLSP
RSG - PLSP - L	Label for RSG - PLSP Long Body
RSG - HLSP	Label for RSG - HLSP

All the labels can be made and supplied in any language, colour or glow-in-the-dark material.

 Customization accepted

LOCKOUT PADLOCK ACCESSORIES

PADLOCK EYES

These Padlock Eyes help you to comply with OSHA Standard, which require the equipment / electrical panels to be locked at the time of servicing / maintenance. Surface mounted padlock eyes help you to install padlocks easily on the electrical panels or other areas where the isolation points are hidden in the cabinets.

- Made from solid stainless steel constant thickness sheet.
- Die cut to hold most of the internationally available padlocks.
- They can be screwed / bolted or rivetted.
- Each set contain - 10 Nos. of padlock eyes.
- Combo pack contains 2 Nos. of each type (Small / Medium / Large) - Total 12 Nos.

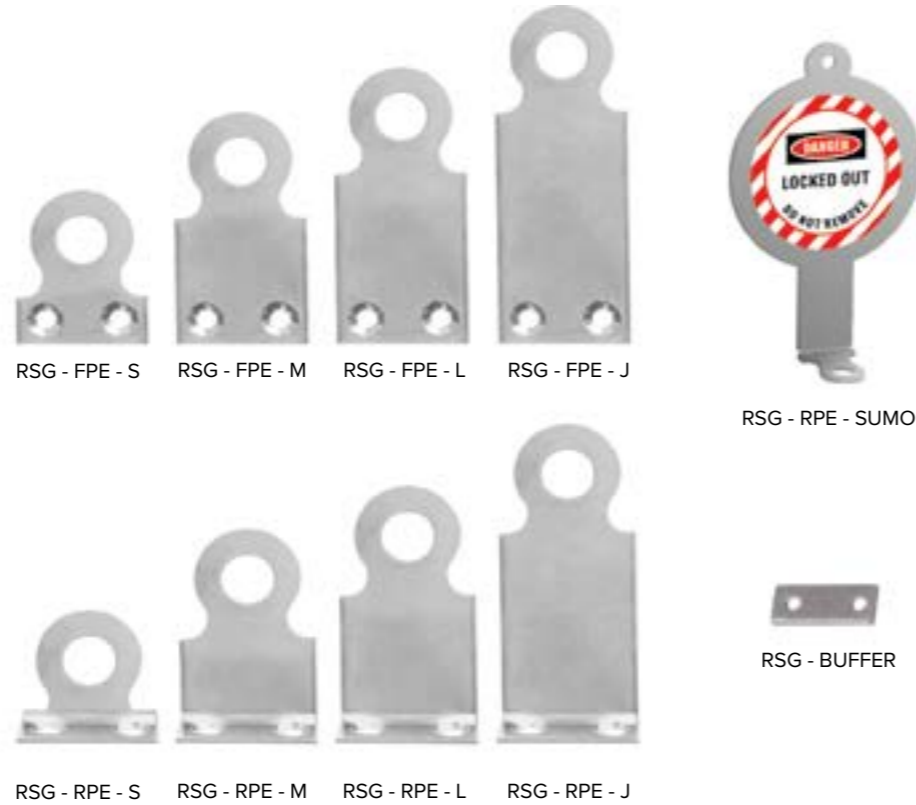

MODEL	PRODUCT DESCRIPTION
RSG - FPE - S	Flat Padlock Eye - Small
RSG - FPE - M	Flat Padlock Eye - Medium
RSG - FPE - L	Flat Padlock Eye - Large
RSG - FPE - J	Flat Padlock Eye - Jumbo
RSG - RPE - S	Right Angled Padlock Eye - Small
RSG - RPE - M	Right Angled Padlock Eye - Medium
RSG - RPE - L	Right Angled Padlock Eye - Large
RSG - RPE - J	Right Angled Padlock Eye - Jumbo
RSG - PE - COMBO	Padlock Eye - Combo (Small / Medium / Large)
RSG - RPE - SUMO	Right Angled Padlock Eye - Sumo
RSG - BUFFER	Metallic Buffer for Padlock Eye
RSG - RIVET	Metallic Rivet for installing Padlock Eye
RSG - RM	Riveting Machine



MODEL	RSG - FPE - S	RSG - FPE - M	RSG - FPE - L	RSG - FPE - J	RSG - RPE - S	RSG - RPE - M	RSG - RPE - L	RSG - RPE - J	RSG - RPE - SUMO
Height (A)	31	48	57	71	22	38	47	60	106
Width (B)	25	25	25	25	25	25	25	25	65
Hole Dia (C)	10	10	10	10	10	10	10	10	8
Depth (D)					13	13	13	13	26

LOCKOUT PADLOCK ACCESSORIES

METAL I.D. TAGS & COLLARS

Metal I.D. Tags and Collars are available for their use on Locks and other lockout devices. Manual Indenter Marking Press is used for punching numbers. Heavy duty zinc plated / SS chain with mounting brackets is available to hang the lockout gadgets / shackle of the padlock near to the pre-designated locations. These products are generally sold in packs of 6 Nos, Longer lengths are available as per requirement.

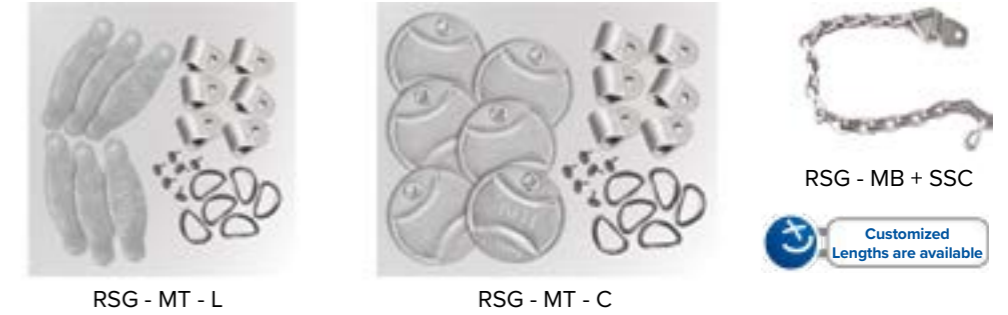

MODEL	PRODUCT DESCRIPTION
RSG - MT - L	Metal Padlock Tags - Long - Set of 6
RSG - MT - C	Metal Padlock Tags - Circular - Set of 6
RSG - MB + SSC	Metallic Mounting Bracket and 9" SS Chain
RSG - SSC	SS Chain (Standard 9 inch) or Order any length

SAFETY PADLOCK HANDY

Ideal for employees who need to carry out multiple isolations. It helps in improving efficiency by keeping hands free. It holds up to 12 Safety Padlocks. The Padlock handy is designed to be worn on the belt or can be hung on the wall / in the special cabinets, when not in use.



MODEL	PRODUCT DESCRIPTION
RSG - HANDY	Safety Padlock Handy
RSG - HANDY + 12	Safety Padlock Handy with 12 Key Alike Red Padlock (RSG - PLSP - KA)



LOCKOUT PADLOCK ACCESSORIES

LOCKOUT MINI PADLOCK STATION

- These wall mounting metallic powder coated padlock stations are supplied with screws.
- Available for 6, 12, 18 & 24 locks.
- Available in red colour as standard lockout practice.



RSG - MPS 6
(with locks)



RSG - MPS 12



RSG - MPS 18



RSG - MPS 24

MODEL	PRODUCT DESCRIPTION			
RSG - MPS - 6	Mini Padlock Station - wall mounted for 6 locks			
RSG - MPS - 12	Mini Padlock Station - wall mounted for 12 locks			
RSG - MPS - 18	Mini Padlock Station - wall mounted for 18 locks			
RSG - MPS - 24	Mini Padlock Station - wall mounted for 24 locks			

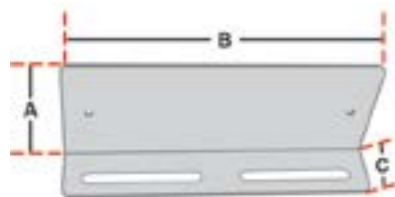

MODEL	RSG - MPS 6	RSG - MPS 12	RSG - MPS 18	RSG - MPS 24
Height (A)	70	70	70	70
Width (B)	30	30	30	30
Depth (C)	130	250	370	490

OPEN LOCKOUT STATION



One Piece Safety Lockout Stations are designed to hold Lockout Padlocks, Hasps and Tags at a central location making them accessible to all for isolating equipments easily. These stations come with bold headings and act as a constant reminder to all the personnel to lockout before commencing maintenance work. Built for the toughest conditions, these moulded lockout stations are made from special grade polystyrene mix. Lockout stations can be supplied with or without contents.

OPEN LOCKOUT STATION

ONE PIECE OPEN LOCKOUT STATION

Available in 7, 16 & 48 lock combinations. The 48 Lock Station can further be extended in multiples of 24 by joining the fragmented pieces together. The front label can be designed and supplied as per the customer's requirements in their own language / text / graphics, with or without their logo etc.



RSG - OPOLS - 7L WG

- 1. PLSP Padlock with Steel Shackle - Key Different - 7 nos.
- 2. Vinyl Coated Hasp - Small - 1 no.
- 3. Vinyl Coated Hasp - Premier - 1 no.
- 4. Lockout Tags - 20 nos.
- 5. RSG - OPOLS - 7L - 1 no.



RSG - OPOLS - 16L WG

- 1. PLSP Padlock with Steel Shackle - Key Different - 16 nos.
- 2. Vinyl Coated Hasp - Small - 1 no.
- 3. Vinyl Coated Hasp - Premier - 1 no.
- 4. Lockout Tags - 10 nos.
- 5. RSG - OPOLS - 16L - 1 no.



RSG - OPOLS - 7L



RSG - OPOLS - 48L WG

- 1. PLSP Padlock with Steel Shackle - Key Different - 48 nos.
- 2. Vinyl Coated Hasp - Small - 1 no.
- 3. Vinyl Coated Hasp - Premier - 1 no.
- 4. Lockout Tags - 40 nos.
- 5. RSG - OPOLS - 48L - 1 no.

MODEL	PRODUCT DESCRIPTION	Size in inch (H x W)
RSG - OPOLS - 7L	One Piece Open Lockout Station for 7 Locks	11.5 x 15.5
RSG - OPOLS - 7L WG	OPOLS - 7L with Goods	11.5 x 15.5
RSG - OPOLS - 16L	One Piece Open Lockout Station for 16 Locks	13.5 x 14.5
RSG - OPOLS - 16L WG	OPOLS - 16L with Goods	13.5 x 14.5
RSG - OPOLS - 48L	One Piece Open Lockout Station for 48 Locks	21.5 x 23
RSG - OPOLS - 48L WG	OPOLS - 48L with Goods	21.5 x 23

While placing order please mention "with" or "without" the lockout gadgets.



OPEN LOCKOUT STATION

ACP: OPEN LOCKOUT STATION - FRONT VIEW

Open Lockout Centers are designed as per internationally accepted configurations to hold Lockout padlocks / tags / hasps near to the isolating points. These Yellow Centers are made of ACP (Aluminium Composite Panel) by using the moulded ABS parts. Transparent hooks and rods are used for aesthetics. These boards can be made and supplied as per the customer's requirements of any size / combinations / presentation type - Front View or Side View. They can be supplied in any language with the company logo.



RSG - OLSF - 5L WG

- 1. PLSP Padlock with Steel Shackle - Key Different - 5 nos.
- 2. Vinyl Coated Hasp - Small - 1 no.
- 3. Lockout Tags - 20 nos.
- 4. RSG - OLSF - 5L - 1 no.



RSG - OLSF - 10L WG

- 1. PLSP Padlock with Steel Shackle - Key Different - 10 nos.
- 2. Vinyl Coated Hasp - Small - 2 no.
- 3. Vinyl Coated Hasp - Premier - 2 no.
- 4. Lockout Tags - 20 nos.
- 5. RSG - OLSF - 10L - 1 no.



RSG - OLSF - 20L WG

- 1. PLSP Padlock with Steel Shackle - Key Different - 20 nos.
- 2. Vinyl Coated Hasp - Small - 1 no.
- 3. Vinyl Coated Hasp - Premier - 1 no.
- 4. Lockout Tags - 30 nos.
- 5. RSG - OLSF - 20L - 1 no.

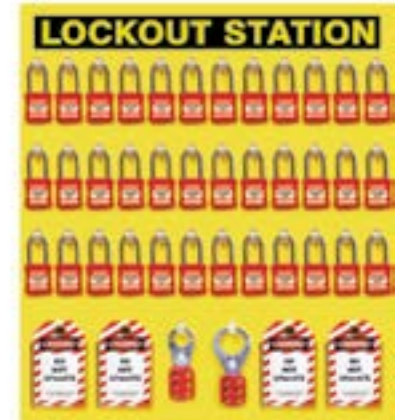

RSG - OLSF - 36L WG

- 1. PLSP Padlock with Steel Shackle - Key Different - 36 nos.
- 2. Vinyl Coated Hasp - Small - 2 no.
- 3. Vinyl Coated Hasp - Premier - 2 no.
- 4. Lockout Tags - 40 nos.
- 5. RSG - OLSF - 36L - 1 no.



RSG - OLCR - 6L WG

- 1. Vinyl Coated Hasp - Small - 1 no.
- 2. Vinyl Coated Hasp - Premier - 1 no.
- 3. Padlock with Regular Shackle - KD - 6 nos.
- 4. Lockout Tags - 20 nos.
- 5. ES - OLCR - 6L - 1 no.

While placing order please mention "with" or "without" the lockout gadgets.



MODEL	PRODUCT DESCRIPTION	Size in inch (H x W)
RSG - OLSF - 5L	Open Lockout Station - Front view for 5 Locks	15 x 12.5
RSG - OLSF - 5L WG	OLSF - 5L with Goods	15 x 12.5
RSG - OLSF - 10L	Open Lockout Station - Front view for 10 Locks	16 x 20
RSG - OLSF - 10L WG	OLSF - 10L with Goods	16 x 20
RSG - OLSF - 20L	Open Lockout Station - Front view for 20 Locks	21 x 20
RSG - OLSF - 20L WG	OLSF - 20L with Goods	21 x 20
RSG - OLSF - 36L	Open Lockout Station - Front view for 36 Locks	27 x 24
RSG - OLSF - 36L WG	OLSF - 36L with Goods	27 x 24
RSG - OLCR - 6L	Open Lockout Center - Red for 6 Locks	14 x 14
RSG - OLCR - 6L WG	OLCR - 6L with Goods	14 x 14

OPEN LOCKOUT STATION

ACP: OPEN LOCKOUT STATION - SIDE VIEW



RSG - 5L - 2P - Y WG

1. PLSP Padlock with Steel Shackle - Key Different - 5 nos.
2. Vinyl Coated Hasp - Small - 1 no.
3. Vinyl Coated Hasp - Premier - 1 no.
4. Lockout Tags - 20 nos.
5. RSG - 5L - 2P - Y - 1 no.



RSG - 10L - 1P - Y WG

1. PLSP Padlock with Steel Shackle - Key Different - 10 nos.
2. Vinyl Coated Hasp - Small - 1 no.
3. Vinyl Coated Hasp - Premier - 1 no.
4. Lockout Tags - 10 nos.
5. RSG - 10L - 1P - Y - 1 no.



RSG - 20L - 2P - Y WG

1. PLSP Padlock with Steel Shackle - Key Different - 20 nos.
2. Vinyl Coated Hasp - Small - 2 no.
3. Vinyl Coated Hasp - Premier - 20 no.
4. RSG - 20L - 2P - Y - 1 no.

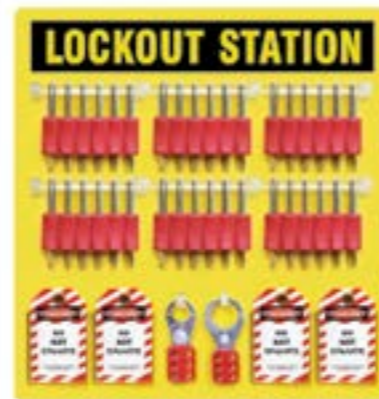

RSG - 36L - 4P - Y WG

1. PLSP Padlock with Steel Shackle - Key Different - 36 nos.
2. Vinyl Coated Hasp - Small - 1 no.
3. Vinyl Coated Hasp - Premier - 1 no.
4. Lockout Tags - 40 nos.
5. RSG - 36L - 4P - Y - 1 no.



RSG - 20L - 2P - Y WG

1. PLSP Padlock with Steel Shackle - Key Different - 20 nos.
2. Lockout Tags - 20 nos.
3. RSG - 20L - 2P - YS - 1 no.

OPEN LOCKOUT STATION

ACP: OPEN LOCKOUT STATION - FRONT VIEW

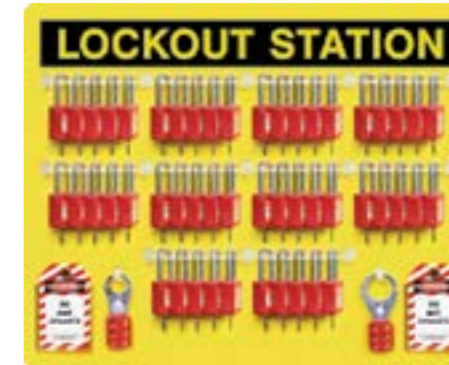

RSG - 50L - 2P - Y WG

1. PLSP Padlock with Steel Shackle - Key Different - 50 nos.
2. Vinyl Coated Hasp - Small - 1 no.
3. Vinyl Coated Hasp - Premier - 1 no.
4. Lockout Tags - 20 nos.
5. RSG - 50L - 2P - Y - 1 no.

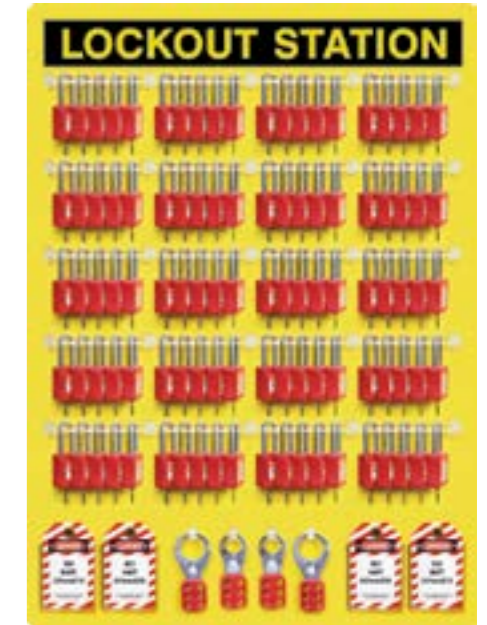

RSG - 100L - 4P - Y WG

1. PLSP Padlock with Steel Shackle - Key Different - 100 nos.
2. Vinyl Coated Hasp - Small - 2 no.
3. Vinyl Coated Hasp - Premier - 2 no.
4. Lockout Tags - 40 nos.
5. RSG - 100L - 4P - Y - 1 no.

MODEL	PRODUCT DESCRIPTION	Size in inch (H x W)
RSG - 5L - 2P - Y	5 Lock Lockout Station	11.5 x 15.5
RSG - 5L - 2P - Y WG	RSG - 5L - 2P - Y with Goods	11.5 x 15.5
RSG - 10L - 1P - Y	10 Lock Lockout Station	13.5 x 13.5
RSG - 10L - 1P - Y WG	RSG - 10L - 1P - Y with Goods	13.5 x 13.5
RSG - 20L - 2P - Y	20 Lock Lockout Station	26 x 12.5
RSG - 20L - 2P - Y WG	RSG - 20L - 2P - Y with Goods	26 x 12.5
RSG - 20L - 2P - YS	20 Lock Lockout Station - Straight	10 x 37.5
RSG - 20L - 2P - YS WG	RSG - 20L - 2P - YS with Goods	10 x 37.5
RSG - 36L - 4P - Y	36 Lock Lockout Station	23 x 22
RSG - 36L - 4P - Y WG	RSG - 36L - 4P - Y with Goods	23 x 22
RSG - 50L - 2P - Y	50 Lock Lockout Station	23 x 28.5
RSG - 50L - 2P - Y WG	RSG - 50L - 2P - Y with Goods	23 x 28.5
RSG - 100L - 4P - Y	100 Lock Lockout Station	39.5 x 28.5
RSG - 100L - 4P - YWG	RSG - 100L - 4P - Y with Goods	39.5 x 28.5

ACP (Aluminium Composite Panel)

While placing order please mention **“with”** or **“without”** the lockout gadgets.



ACP (Aluminium Composite Panel)

While placing order please mention **“with”** or **“without”** the lockout gadgets.



OPEN LOCKOUT STATION

LOCKOUT HASP HANGER

This hasp hanger is generally installed in the maintenance rooms. Provision for hanging 30 lockout hasp. Made of ACP (Aluminium Composite Panel) with clear hangers.

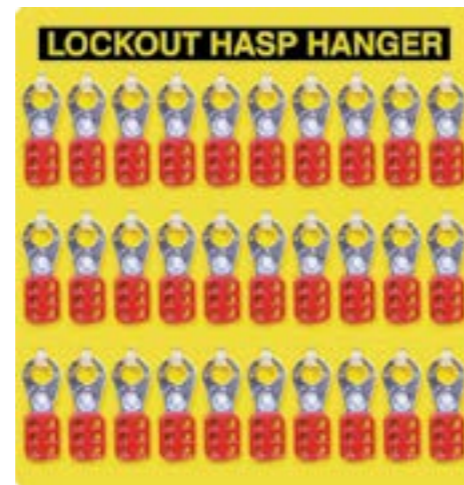

RSG - LHH - 30H

MODEL	PRODUCT DESCRIPTION	Size in inch (H x W)
RSG - LHH - 30H	Lockout Hasp Hanger for 30 Hasps (VCH - S)	21 x 20
RSG - LHH - 30H WG	RSG - LHH - 30H with Goods	21 x 20

While placing order please mention "with" or "without" the lockout gadgets.



COMPACT LOCKOUT STATION

These compact lockout tagout stations are generally installed next to equipments which require small lockouts on regular basis. They are very helpful in keeping the LOTO gadgets handy & easily accessible to the users.

Provision for hanging the lockout padlocks and lockout hasp is an inbuilt feature of these compact panels.



RSG - 610 - Y WG



RSG - 810 - Y WG

1. PLSP Padlock with Steel Shackle - Key Different - 2 nos.
2. Vinyl Coated Hasp - Small - 1 no.
3. Vinyl Coated Hasp - Premier - 1 no.
4. Lockout Tags - 10 nos.
5. Nylon Ties for Tags - 10 nos.
6. RSG - 610 - Y - 1 no.

1. PLSP Padlock with Steel Shackle - Key Different - 3 nos.
2. Vinyl Coated Hasp - Small - 1 no.
3. Vinyl Coated Hasp - Premier - 1 no.
4. 1 Piece each of all the PI / PO / POW CCBL - 1 set
5. Large Circuit Breaker Lockout Round Handle - 10 nos.
6. Universal Golden Toggle - Miniature Circuit Breaker Lockout - 1 no.
7. Lockout Tags - 10 nos
8. Nylon Ties for Tags - 10 nos
9. RSG - 810 - Y - 1 no.

MODEL	PRODUCT DESCRIPTION	Size in inch (H x W)
RSG - 610 - Y	Compact Lockout Station - Small	21 x 20
RSG - 610 - Y WG	RSG - 610 - Y with Goods	21 x 20
RSG - 810 - Y	Compact Lockout Station - Large	21 x 20
RSG - 810 - Y WG	RSG - 810 - Y with Goods	21 x 20



RSG - 610 - Y



RSG - 810 - Y



SHADOW LOCKOUT STATION



- Ideal for use in localised areas, to keep isolation devices close to the machine that is to be locked out.
- Highly visible striped design.
- Shadows are a status indicators, clearly showing which piece of equipment is in use.
- Lockout boards come either unfilled, or fully loaded.
- Made from 4 mm ACP boards.
- Special lockout shadow boards can be created along with the machine specific procedure for bigger machines.

SHADOW LOCKOUT STATION

These shadow lockout stations are duly customizable.
They can be supplied in different colours, shapes, designs and as per your required specifications / combinations.



RSG - SLS - 04 WG

- 1. PLSP Padlock with Steel Shackle - Key Different - 4 nos.
- 2. Vinyl Coated Hasp - Small - 1 no.
- 3. Vinyl Coated Hasp - Premier - 1 no.
- 4. Lockout Tags - 10 nos.
- 5. RSG - SLS - 04 - 1 no.



RSG - SLS - 04



RSG - SLS - 20 WG

- 1. PLSP Padlock with Steel Shackle - Key Different - 20 nos.
- 2. Vinyl Coated Hasp - Small - 1 no.
- 3. Vinyl Coated Hasp - Premier - 1 no.
- 4. Lockout Tags - 20 nos.
- 5. RSG - SLS - 20 - 1 no.



RSG - SLS - 10 WG

- 1. PLSP Padlock with Steel Shackle - Key Different - 10 nos.
- 2. Vinyl Coated Hasp - Small - 1 no.
- 3. Lockout Tags - 20 nos.
- 4. RSG - SLS - 10 - 1 no.



RSG - SLS - 50 WG

- 1. PLSP Padlock with Steel Shackle - Key Different - 50 nos.
- 2. Vinyl Coated Hasp - Small - 1 no.
- 3. Vinyl Coated Hasp - Premier - 1 no.
- 4. Lockout Tags - 20 nos.
- 5. RSG - SLS - 50 - 1 no.

SHADOW LOCKOUT STATION

Also available:



Cable Lockout Station



Plug Lockout Station



Pin & Sleeve Lockout Station



Fuse Lockout Station

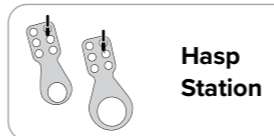

Hasp Station



Tag Station



RSG - SLS - 100 WG

- 1. PLSP Padlock with Steel Shackle - Key Different - 100 nos.
- 2. Vinyl Coated Hasp - Small - 3 no.
- 3. Vinyl Coated Hasp - Premier - 4 no.
- 4. Lockout Tags - 40 nos.
- 5. RSG - SLS - 50 - 1 no.

While placing order please mention **“with”** or **“without”** the lockout gadgets.



While placing order please mention **“with”** or **“without”** the lockout gadgets.



MODEL	PRODUCT DESCRIPTION	Size in inch (H x W)
RSG - SLS - 04	Shadow Lockout Station for 4 Locks	17.5 x 11.75
RSG - SLS - 04 WG	RSG - SLS - 04 with Goods	17.5 x 11.75
RSG - SLS - 10	Shadow Lockout Station for 10 Locks	23.5 x 15
RSG - SLS - 10 WG	RSG - SLS - 10 with Goods	23.5 x 15
RSG - SLS - 20	Shadow Lockout Station for 20 Locks	22 x 23
RSG - SLS - 20 WG	RSG - 20L - 2P - Y with Goods	22 x 23
RSG - SLS - 50	Shadow Lockout Station for 50 Locks	36 x 23
RSG - SLS - 50 WG	RSG - SLS - 50 with Goods	36 x 23
RSG - SLS - 100	Shadow Lockout Station for 100 Locks	38.5 x 46
RSG - SLS - 100 WG	RSG - SLS - 100 with Goods	38.5 x 46

SHADOW LOCKOUT STATION

YELLOW & BLACK SHADOW VALVE LOCKOUT STATION



RSG - YB SVLS WG

- | | |
|--|-----------|
| 1. De Electric Hasp 6 holes | - 2 nos. |
| 2. PLSP Padlock with Steel Shackle - Key Different | - 6 nos. |
| 3. Gate Valve Lockout (RSG - 02 - GVL) | - 1 no. |
| 4. Gate Valve Lockout (RSG - 04 - GVL) | - 1 no. |
| 5. Gate Valve Lockout (RSG - 06 - GVL) | - 1 no. |
| 6. Gate Valve Lockout (RSG - 08 - GVL) | - 1 no. |
| 7. Gate Valve Lockout (RSG - 10 - GVL) | - 1 no. |
| 8. Top Rail - Ball Valve Lockout Small | - 1 no. |
| 9. Top Rail - Ball Valve Lockout Large | - 1 no. |
| 10. One Piece Steel - Small Ball Valve Lockout | - 1 no. |
| 11. One Piece Steel - Large Ball Valve Lockout | - 1 no. |
| 12. Lockout Tags | - 10 nos. |
| 13. Yellow & Black Shadow Valve Lockout Station | - 1 no. |

MODEL	PRODUCT DESCRIPTION	Size in inch (H x W)
RSG - YB SVLS	Yellow & Black Shadow Valve Lockout Station	34.5 x 32.5
RSG - YB SVLS WG	RSG - YB SVLS with Goods	34.5 x 32.5



YELLOW & BLACK SHADOW ELECTROMECHANICAL LOCKOUT STATION



RSG - YB SLS - EM WG

- | | |
|---|-----------|
| 1. Vinyl Coated Hasp - Small | - 5 nos. |
| 2. PLSP Padlock with Steel Shackle - Key Different | - 12 nos. |
| 3. 2 Piece each of all the PI / PO / POW & Tie Bar CCBL | - 1 set |
| 4. Universal Fuse Holder Lockout (Thin & Wide) | - 1 set |
| 5. Miniature Circuit Breaker Lockout - Yellow | - 2 nos. |
| 6. Universal Miniature Circuit Breaker Lockout - Blue | - 2 nos. |
| 7. Universal Large Circuit Breaker Lockout - Big Size | - 2 nos. |
| 8. Universal Multi - Functional Circuit Breaker Lockout | - 2 nos. |
| 9. Computer Power Cord Lockout | - 1 no. |
| 10. Economy Multipurpose Cable Lockout with Tool & 2 Mtrs. Vinyl Coated Steel Cable with loop | - 1 set |
| 11. Small Plug Lockout - Premier | - 1 no. |
| 12. Large Plug Lockout - Premier | - 1 no. |
| 13. Pneumatic Lockout - 3 Way | - 2 nos. |
| 14. Gate Valve Lockout (RSG - 02 - GVL) | - 1 no. |
| 15. Gate Valve Lockout (RSG - 04 - GVL) | - 1 no. |
| 16. Gate Valve Lockout (RSG - 06 - GVL) | - 1 no. |
| 17. Gate Valve Lockout (RSG - 08 - GVL) | - 1 no. |
| 18. Gate Valve Lockout (RSG - 10 - GVL) | - 1 no. |
| 19. Top Rail - Ball Valve Lockout Small | - 1 no. |
| 20. Top Rail - Ball Valve Lockout Large | - 1 no. |
| 21. Lockout Tags | - 30 nos. |
| 22. Yellow & Black Shadow Electromechanical Lockout Station | - 1 no. |

MODEL	PRODUCT DESCRIPTION	Size in inch (H x W)
RSG - YB S EMLS	Yellow & Black Shadow Electromechanical Lockout Station	31.5 x 48
RSG - YB S EMLS WG	RSG - YB S EMLS with Goods	31.5 x 48

While placing order please mention "with" or "without" the lockout gadgets.



SHADOW LOCKOUT STATION

YELLOW & BLACK SHADOW CIRCUIT BREAKER LOCKOUT STATION



RSG - YB SCBLS WG

- | | |
|--|-----------|
| 1. De Electric Hasp 6 holes | - 2 nos. |
| 2. PLSP De - Electric Padlock with Nylon Shackle - Key Different | - 4 nos. |
| 3. 2 Piece each of all the PI / PO / POW & Tie Bar CCBL | - 1 set |
| 4. Miniature Circuit Breaker Lockout - Yellow | - 2 no. |
| 5. Universal Miniature Circuit Breaker Lockout - Blue | - 2 no. |
| 6. Universal Large Circuit Breaker Lockout - Big Size | - 2 no. |
| 7. Universal Multi - Functional Circuit Breaker Lockout | - 2 no. |
| 8. Universal Golden Toggle - Miniature Circuit Breaker Lockout | - 6 no. |
| 9. Lockout Tags | - 10 nos. |
| 10. Yellow & Black Shadow Circuit Breaker Lockout Station | - 1 no. |

MODEL	PRODUCT DESCRIPTION	Size in inch (H x W)
RSG - YB SCBLS	Yellow & Black Shadow Circuit Breaker Lockout Station	23 x 17
RSG - YB SCBLS WG	RSG - YB SCBLS with Goods	23 x 17

YELLOW & BLACK SHADOW WORK PERMIT STATION



RSG - YB SWPS WG

- | | |
|--|-----------|
| 1. PLSP Padlock with Steel Shackle - Key Different | - 4 nos. |
| 2. Permit Holder | - 1 no. |
| 3. Group Lock Box - Top Sliding Fascia Panel | - 1 no. |
| 4. Lockout Tags | - 10 nos. |
| 5. Yellow & Black Shadow Work Permit Station | - 1 no. |

MODEL	PRODUCT DESCRIPTION	Size in inch (H x W)
RSG - YB SWPS	Yellow & Black Shadow Work Permit Station	23.5 x 28
RSG - YB SWPS WG	RSG - YB SWPS with Goods	23.5 x 28

YELLOW & BLACK SHADOW GROUP LOCKOUT STATION



RSG - YB SGLS WG

- | | |
|--|-----------|
| 1. PLSP Padlock with Steel Shackle - Key Different | - 24 nos. |
| 2. Permit Holder | - 3 nos. |
| 3. Group Lock Box - Top Sliding Fascia Panel | - 3 nos. |
| 4. Lockout Tags | - 30 nos. |
| 5. Yellow & Black Shadow Group Lockout Station | - 1 no. |

MODEL	PRODUCT DESCRIPTION	Size in inch (H x W)
RSG - YB SGLS	Yellow & Black Shadow Group Lockout Station	48 x 46
RSG - YB SGLS WG	RSG - YB SGLS with Goods	48 x 46

While placing order please mention "with" or "without" the lockout gadgets.



SHADOW LOCKOUT STATION

SHADOW LOCKOUT STATION: ELECTRICAL



RSG - SLS - E

1. Vinyl Coated Hasp - Small	- 2 nos.
2. De Electric Slider Hasp for 4 Locks / 3 mm shackle	- 2 nos.
3. De Electric Slider Hasp for 4 Locks / 6 mm shackle	- 2 nos.
4. De Electric Hasp 3 holes / 3 mm shackle	- 2 nos.
5. De Electric Hasp 3 holes / 6 mm shackle	- 2 nos.
6. De Electric Hasp 6 holes / 6 mm shackle	- 2 nos.
7. HLSP De Electric Padlock with Nylon shackle - Key Different	- 10 nos.
8. 2 Piece each of all the PI / PO / POW & Tie Bar CCBL	- 1 set
9. Universal Circuit Breaker Lockout : A Tail Type with Twister Screw	- 2 nos.
10. Universal Multi - Functional Circuit Breaker Lockout	- 2 nos.
11. Universal Golden Toggle - Miniature Circuit Breaker Lockout	- 2 nos.
12. Two Way Black MG Toggle Hasp	- 2 nos.
13. Universal Multi Pole Breaker Lockout	- 2 nos.
14. Combo - Tool Free Circuit Breaker Lockout	- 2 set
15. 1 Piece each of Grip Tight Circuit Breaker Lockout - Small & Large	- 1 set
16. Clamp On Breaker Lockout - Small for 120 / 277 V breakers	- 2 nos.
17. Cleat for Small Clamp On Breaker Lockout	- 2 nos.
18. Clamp On Breaker Lockout - Medium for 480 / 600 V breakers	- 1 no.
19. Cleat for Medium Clamp On Breaker Lockout	- 1 no.
20. Clamp On Breaker Lockout - Large fits on breaker switches up to 21 / 4" wide and 7 / 8" thick	- 1 no.
21. Large Circuit Breaker Lockout Round Handle	- 2 nos.
22. Normal Push Button Lockout for Electrical Panels - Mushroom	- 2 nos.
23. Oversize Push Button Lockout - Cocoon	- 2 nos.
24. Pin & Sleeve Socket Lockout - Small	- 1 no.
25. Pin & Sleeve Socket Lockout - Medium	- 1 no.
26. Pin & Sleeve Socket Lockout - Large	- 1 no.
27. Pin & Sleeve Plug Lockout	- 3 nos.
28. Small Plug Lockout	- 1 no.
29. Large Plug Lockout	- 1 no.
30. Computer Power Cord Lockout	- 1 no.
31. Universal Fuse Holder Lockout - Red	- 2 nos.
32. Universal Fuse Holder Lockout - Slim	- 2 nos.
33. Fuse Holder Lockout - Thin Grip Type	- 2 nos.
34. Fuse Holder Lockout - Wide Grip Type	- 2 nos.
35. Safe Grip Fuse Puller	- 1 no.
36. Economy Multipurpose Cable Lockout with 2 Mtrs. Vinyl Coated Steel Cable without loop	- 2 set
37. Squeezer Multipurpose Cable Lockout - DE Electric - Yellow	- 2 set
38. Hanging Lockout Sign (6" x 8")	- 1 no.
39. Lockout Tags	- 20 nos.
40. Nylon Ties for Tags	- 20 nos.
41. Lockout Pen for Tags	- 1 no.
42. Screw Driver	- 1 no.

While placing order please mention **"with"** or **"without"** the lockout gadgets.



MODEL	PRODUCT DESCRIPTION	Size in inch (H x W)
RSG - SLS - E	Shadow Lockout Station - Electrical	49 x 46.5
RSG - SLS - E WG	RSG - SLS - E with Goods	49 x 46.5

SHADOW LOCKOUT STATION

SHADOW LOCKOUT STATION: MECHANICAL



RSG - SLS - M

1. Vinyl Coated Hasp - Small	- 2 nos.
2. Vinyl Coated Hasp - Premier	- 2 nos.
3. Stainless Steel Hasp - 5 mm shackle	- 2 nos.
4. HLSPadlock with Steel shackle - Key Different	- 10 nos.
5. Gate Valve Lockout (RSG - 02 - GVL)	- 1 no.
6. Gate Valve Lockout (RSG - 04 - GVL)	- 1 no.
7. Gate Valve Lockout (RSG - 06 - GVL)	- 1 no.
8. Gate Valve Lockout (RSG - 08 - GVL)	- 1 no.
9. Gate Valve Lockout (RSG - 10 - GVL)	- 1 no.
10. Adjustable Gate Valve Lockout	- 1 no.
11. Top Rail - Ball Valve Lockout Small	- 1 no.
12. Top Rail - Ball Valve Lockout Large	- 1 no.
13. One Piece Steel - Small Ball Valve Lockout	- 1 no.
14. One Piece Steel - Large Ball Valve Lockout	- 1 no.
15. Universal Butterfly Valve Lockout with RSG - GTMCL + 2C	- 1 set
16. Economy Multipurpose Cable Lockout with 2 Mtrs. Vinyl Coated Steel Cable without loop	- 1 set
17. Mettlic Multipurpose Cable Lockout with 2 mtrs. Stainless Steel Cable	- 1 set
18. Cylinder Lockout (Yellow Lid)	- 1 no.
19. Gate Valve Cylinder Lockout	- 1 no.
20. Pneumatic Lockout - Straight with 9 Holes	- 1 no.
21. Hanging Lockout Sign (6" x 8")	- 1 no.
22. Lockout Tags	- 20 nos.
23. Nylon Ties for Tags	- 20 nos.
24. Lockout Pen for Tags	- 1 no.

While placing order please mention **"with"** or **"without"** the lockout gadgets.



MODEL	PRODUCT DESCRIPTION	Size in inch (H x W)
RSG - SLS - M	Shadow Lockout Station - Mechanical	49 x 46.5
RSG - SLS - MWG	RSG - SLS - M with Goods	49 x 46.5

SHADOW LOCKOUT STATION

SHADOW LOCKOUT STATION: ELECTROMECHANICAL



RSG - SLS - EM

- | | |
|---|-----------|
| 1. Vinyl Coated Hasp - Small | - 2 nos. |
| 2. Vinyl Coated Hasp - Premier | - 2 nos. |
| 3. Stainless Steel Hasp - 5 mm shackle | - 2 nos. |
| 4. De Electric Slider Hasp for 4 Locks / 3 mm shackle | - 2 nos. |
| 5. De Electric Slider Hasp for 4 Locks / 6 mm shackle | - 2 nos. |
| 6. PLSP Padlock with Steel Shackle - Key Different | - 5 nos. |
| 7. PLSP De - Electric Padlock with Nylon Shackle - Key Different | - 5 nos. |
| 8. 2 Piece each of all the PI / PO / POW & Tie Bar CCBL | - 1 set |
| 9. Universal Circuit Breaker Lockout: A Tail Type with Twister Screw | - 2 nos. |
| 10. Universal Multi - Functional Circuit Breaker Lockout | - 2 nos. |
| 11. Universal Golden Toggle - Miniature Circuit Breaker Lockout | - 2 nos. |
| 12. Computer Power Cord Lockout | - 1 no. |
| 13. Small Plug Lockout | - 1 no. |
| 14. Large Plug Lockout | - 1 no. |
| 15. Large Circuit Breaker Lockout Round Handle | - 2 nos. |
| 16. Normal Push Button Lockout for Electrical Panels - Mushroom | - 2 nos. |
| 17. Oversize Push Button Lockout - Cocoon | - 1 no. |
| 18. Gate Valve Lockout (RSG - 08 - GVL) | - 1 no. |
| 19. Gate Valve Lockout (RSG - 10 - GVL) | - 1 no. |
| 20. Adjustable Gate Valve Lockout | - 2 nos. |
| 21. Top Rail - Ball Valve Lockout Small | - 1 no. |
| 22. Top Rail - Ball Valve Lockout Large | - 1 no. |
| 23. Universal Butterfly Valve Lockout with RSG - GTMCL + 2C | - 1 set |
| 24. Economy Multipurpose Cable Lockout with 2 Mtrs. Vinyl Coated Steel Cable without loop | - 2 set |
| 25. Cylinder Lockout (Yellow Lid) | - 1 no. |
| 26. Pneumatic Lockout - Straight with 9 Holes | - 1 no. |
| 27. Hanging Lockout Sign (6" x 8") | - 1 no. |
| 28. Lockout Tags | - 30 nos. |
| 29. Nylon Ties for Tags | - 30 nos. |
| 30. Lockout Pen for Tags | - 1 no. |
| 31. Screw Driver | - 1 no. |

MODEL	PRODUCT DESCRIPTION	Size in inch (H x W)
RSG - SLS - EM	Shadow Lockout Station - Electromechanical	49 x 46.5
RSG - SLS - EM WG	RSG - SLS - AM with Goods	49 x 46.5

SHADOW LOCKOUT STATION

CUSTOMIZED SHADOW LOCKOUT STATIONS

We design the shadow stations as per the location and customer's requirement.

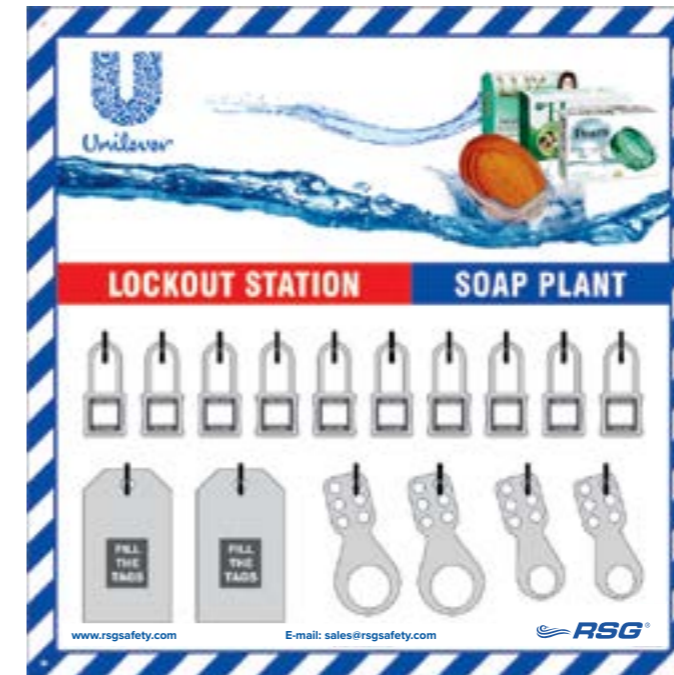

Customization accepted



SHADOW LOCKOUT STATION

CUSTOMIZED SHADOW LOCKOUT STATIONS

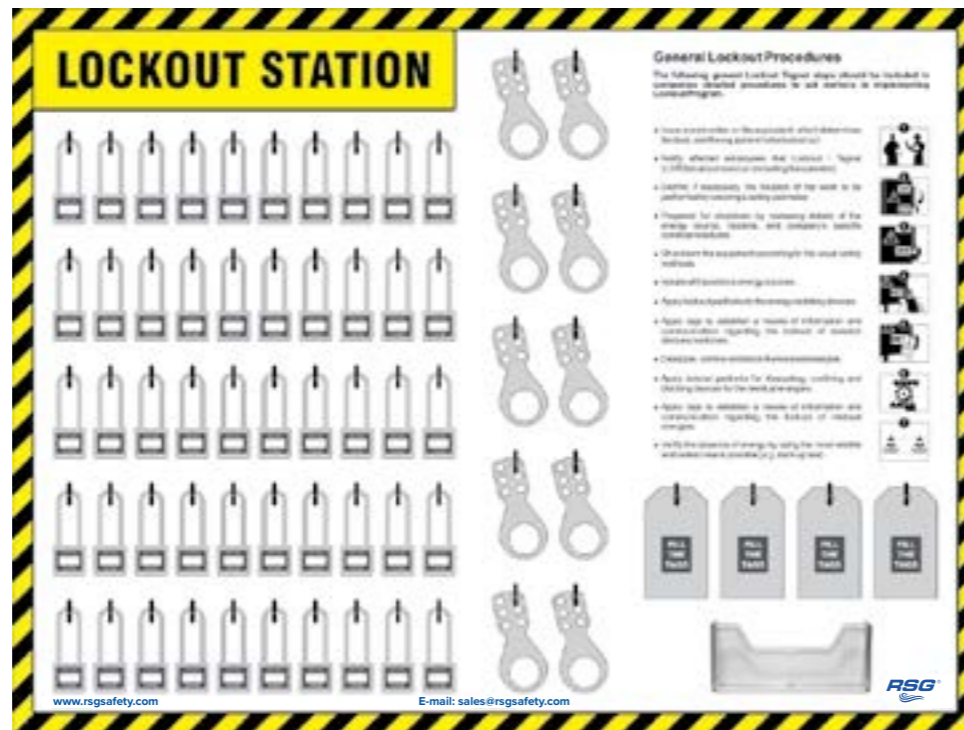

We design the shadow stations as per the location and customer's requirement.



LOCKOUT TAGOUT STATION



Lockout stations and kits are equipped with the tools / gadgets that are needed to isolate mechanical and electrical control points. These stations are portable or wall mounted. Are available in different formats and sizes to take care of the individual needs of machines / departments / location / plants etc. They are made and supplied as per the requirements of customers too. These durable, user friendly carry away or wall / stand mounted stations offer the ultimate storage space for large facilities.



LOCKOUT TAGOUT STATION

LOCKOUT TAGOUT STATION: METALLIC

- Made of special grade Metallic Sheet.
- Powder coated station supplied with 2 Nos. of inter changeable shelves & slotted side panels in the box body. Provision for the hangers for locks / keys / can also be made /supplied on request.
- Available in plain or with clear fascia lockable shutters. Normally supplied in yellow or red colour. If ordered more than 10 Nos. - Customized Printing of Logo / Dept. Name etc. is done free of charge.
- For easy handling and carrying of these boxes - ergonomic stainless steel easy-to-grip handle is always provided on the top side for easy transportation.
- 4 die cut holes are available for wall mounting.



RSG - LTS - 6



RSG - LTS - 6 C



RSG - LTS - 6 + GB



RSG - LBTO



RSG - LBTT



RSG - LTS - 9



RSG - LTS - 9 C



RSG - LTS - 10



RSG - LTS - 10 C



RSG - LTS - 6 ST



RSG - LTHS

MODEL	PRODUCT DESCRIPTION
RSG - LTS - 6	Lockout Tagout Station - 16" x 14" x 6"
RSG - LTS - 6 C	Lockout Tagout Station - 16" x 14" x 6" with Clear Fascia
RSG - LTS - 6 + GB	Lockout Tagout Station - 21" x 14" x 6" with Group Lock Box
RSG - LTS - 9	Lockout Tagout Station - 30" x 15" x 9"
RSG - LTS - 9 C	Lockout Tagout Station - 30" x 15" x 9" with Clear Fascia
RSG - LTS - 10	Lockout Tagout Station - 24" x 22" x 10"
RSG - LTS - 10 C	Lockout Tagout Station - 24" x 22" x 10" with Clear Fascia
RSG - LTS - 6 ST	Lockout Tagout Station - 16" x 14" x 6" Standard
RSG - LTHS	Lock / Tag / Hasp Station - 13 x 17.5" x 2.5"
RSG - LBTO	Lockout Box Top Opening - 12" x 13" x 5"
RSG - LBTT	Lockout Box Table Type - 20" x 30" x 8"



LOCKOUT TAGOUT STATION

LOCKOUT TAGOUT CABINET: METALLIC RED

- Lock-out cabinets prevent theft of lock-out hardware, secures supplies.
- Controls equipment usage and keep - dust, chemicals and moisture away from lock-out supplies.
- These steel cabinets are suitable for most of the harsh plant conditions.
- Bright red / yellow color is easily recognizable.
- Available in various sizes to fit in most work areas / requirements. Choose from filled or unfilled cabinets.
- Supplied with labeled / screen printed fascias.

Available with or without goods



MODEL	PRODUCT DESCRIPTION	Size in inch (H x W x D)
RSG - RLTC - S	Red Lockout Tagout Cabinet - Small	14.5 x 10.5 x 4.25
RSG - RLTC - M	Red Lockout Tagout Cabinet - Medium	18.25 x 15.5 x 4.25
RSG - RLTC - L	Red Lockout Tagout Cabinet - Large	18.25 x 31 x 4.25



LOCKOUT TAGOUT CABINET: METALLIC RED

- These yellow colour lockout cabinets are available in 3 sizes and they can be ordered according to requirement of lockout products required for each department or area.
- These wall cabinets can be purchased either filled with components or just as empty.
- RSG - YLTS - 4L contains: 10 Tags / 4 padlocks / 2 hasps
- RSG - YLTS - 8L contains: 20 Tags / 8 padlocks / 4 hasps
- RSG - YLTS - 20L contains: 40 Tags / 20 padlocks / 8 hasps

Available with or without goods



RSG - YLTC - 20L

RSG - YLTC - 8L

RSG - YLTC - 4L

MODEL	PRODUCT DESCRIPTION	Size in inch (H x W x D)
RSG - YLTC - 4L	Yellow Lockout Tagout Cabinet for 4 Locks	7 x 8 x 3
RSG - YLTC - 8L	Yellow Lockout Tagout Cabinet for 8 Locks	11 x 8 x 3
RSG - YLTC - 20L	Yellow Lockout Tagout Cabinet for 20 Locks	16 x 12 x 3

PORTABLE LOCKOUT STATION



- Portable lockout tagout ready access stations are perfect for transporting and storing critical lockout tagout (LOTO) equipment.
- They come with a solid black handle for easy portability and ensure that lockout devices remain easily accessible and ready to use whenever needed.
- These portable stations are made of polypropylene for rugged durability.
- Semi-transparent hinged cover with locking mechanism protects contents from harsh environments and prevents unauthorized access.
- Truly unbreakable lemon yellow colour base and semi clear lockable cover with provision of hanging the same on the wall, on 2 slots & 2 holes with overall size of 440 x 380 mm.



RSG - YPPS



RSG - YPLS



RSG - YPLS - ED 02



RSG - YPPS WG



RSG - YPLS are available with two shelves.

1. Vinyl Coated Hasp - Small	- 2 nos.
2. Vinyl Coated Hasp - Premier	- 4 nos.
3. Jacket Padlock with Regular Shackle - Key Different	- 15 nos.
4. Jacket Padlock Mini	- 1 no.
5. Lockout Economy Tags	- 25 nos.
6. Nylon Ties for Tags	- 25 nos.
7. Yellow Portable Padlock Station	- 1 no.

1. Electrical Panel Lockout - Round 45	- 1 no.
2. Electrical Panel Lockout - Round 55	- 1 no.
3. Electrical Panel Lockout - Square Box - Small	- 1 no.
4. Electrical Panel Lockout - Square Box - Big 45°	- 1 no.
5. Electrical Panel Lockout - Square Box - Big 90°	- 1 no.
6. De Electric Slider Hasp for 4 Locks / 3 mm shackle	- 1 no.
7. De Electric Slider Hasp for 4 Locks / 6 mm shackle	- 1 no.
8. De Electric Hasp 3 holes / 3 mm shackle	- 2 nos.
9. De Electric Hasp 3 holes / 6 mm shackle	- 2 nos.
10. De Electric Hasp 6 holes / 6 mm shackle	- 2 nos.
11. Economy Multipurpose Cable Lockout with Tool & 2 Mtrs. cable with loop	- 1 set
12. PLSP De Electric Padlock with Nylon Shackle Red Colour - Key Different	- 3 nos.
13. PLSP De Electric Padlock with Nylon Shackle Yellow Colour - Key Alike	- 2 nos.
14. Cylinder Electrical Plug Lockout	- 1 no.
15. Small Plug Lockout	- 1 no.
16. Large Plug Lockout	- 1 no.
17. Electrical Panel Handle Lockout	- 1 no.
18. Squeezer Multipurpose Cable Lockout - Metallic Blue	- 1 no.
19. Combo Miniature Circuit Breaker Lockout	- 1 set
20. Universal Fuse Holder Lockout - Red	- 1 no.
21. 1 Piece each of all the PI / PO / POW & Tie Bar CCBL	- 1 set
22. Large Circuit Breaker Lockout Round Handlem	- 1 no.
23. Universal Circuit Breaker Lockout AES - & B TYPLS -Type	- 2 nos.
24. Computer Power Cord Lockout	- 2 nos.
25. Fuse Holder Lockout - Thin Grip Type	- 1 no.
26. Fuse Holder Lockout - Wide Grip Type	- 1 no.
27. Premier Fuse Holder Lockout	- 1 no.
28. Lockout Tags	- 20 nos.
29. Nylon Ties for Tags	- 20 nos.
30. Lockout Pen for Tags	- 1 no.
31. Lockout Training Booklet	- 1 no.
32. Screw Driver	- 1 no.
33. Yellow Portable Lockout Station	- 1 no.

MODEL	PRODUCT DESCRIPTION	Size in inch (H x W x D)
RSG - YPPS	Yellow Portable Padlock Station	17.25 x 15.75 x 2.5
RSG - YPPS WG	RSG - YPPS with Goods	17.25 x 15.75 x 2.5



MODEL	PRODUCT DESCRIPTION	Size in inch (H x W x D)
RSG - YPLS	Yellow Portable Lockout Station	17.25 x 15.75 x 6.75
RSG - YPLS - ED 02	RSG - YPLS with Goods	17.25 x 15.75 x 6.75

KEY CABINETS

These quality range of key cabinets offer a simple and affordable solution to your key storage requirement. To manage the keys of lockout padlocks systematically, it is very important to use key cabinets for easy access at the time of requirement and to make the LOTO system functional. They are made of special grade metallic sheet & have locking arrangement.

- Sturdy steel cabinets, with tough powder coated yellow finish.
- Supplied with security lock and 2 keys.
- Clear front allows quick visual check of 'keys out' without unlocking the cabinet.
- 4 wall mounting holes are pre punched at the base plate of the panel for an easy installation.



RSG - KC - 60

RSG - KC - 110

RSG - KC - 210

RSG - KC - 420

RSG - KC - CF 30

RSG - KC - CF 60

RSG - KC - CF 160

RSG - KDC - CF 36

MODEL	PRODUCT DESCRIPTION	Size in inch (H x W x D)
RSG - KC - 60	Key Cabinet for 60 Keys	18.25 x 15.5 x 2
RSG - KC - 110	Key Cabinet for 110 Keys	18.25 x 15.5 x 2
RSG - KC - 210	Key Cabinet for 210 Keys	18.25 x 15.5 x 4
RSG - KC - 420	Key Cabinet for 420 Keys	18.5 x 31.25 x 4.25
RSG - KC - CF 30	Key Cabinet with Clear Fascia - 30 Keys	14 x 10.5 x 2
RSG - KC - CF 60	Key Cabinet with Clear Fascia - 60 Keys	18.25 x 15.5 x 2
RSG - KC - CF 160	Key Cabinet with Clear Fascia - 160 Keys	18.25 x 15.5 x 4
RSG - KDC - CF 36	Key & Document Cabinet with Clear Fascia	17 x 12.5 x 3



PADLOCK CABINETS

Made of special grade Metallic Sheet. They all have a locking arrangement. For easy opening - an easy-to-grip, ergonomic SS handle / PVC Bracket is provided on the front side.

Each box is powder coated red in colour. Clear Fascia Padlock Cabinet gives a clear view of the padlocks kept inside.

- Designed to store Lockout padlocks.
- Deep cabinet with staggered hooks allows extra space for padlocks to hang.
- Supplied with security lock and 2 keys.
- 4 wall mounting holes are pre punched at the base plate of the panel for an easy installation.
- In 2" deep cabinets, each hook can hold two padlocks.



RSG - PC 21

RSG - PC 112

RSG - PC 220

RSG - PC - CF 10

RSG - PC - CF 21

RSG - PC - CF 28

RSG - PC - CF 84

MODEL	PADLOCK CABINET DESCRIPTION	Size in inch (H x W x D)
RSG - PC - 21	21 hooks and 41 Locks	18.25 x 15.5 x 2
RSG - PC - 112	112 Locks	23 x 15.5 x 5.5
RSG - PC - 220	220 Locks	23 x 31.5 x 5.5
RSG - PC - CF 10	Clear Fascia 10 hooks and 19 Locks	14 x 10.5 x 2
RSG - PC - CF 21	Clear Fascia 21 hooks and 41 Locks	18.25 x 15.5 x 2
RSG - PC - CF 28	Clear Fascia 28 hooks and 55 Locks	23 x 15.5 x 2
RSG - PC - CF 84	Clear Fascia 84 Locks	23 x 15.5 x 5.5



**HASP & TAG
CABINETS**

- Designed to store Lockout Hasps & Tags.
- 50 Nos. Hasps and 50 Nos. Tags can be stored in RSG - H+T C 50.
- Supplied with security lock and 2 keys.
- 4 wall mounting holes are pre punched at the base plate of the panel for an easy installation.

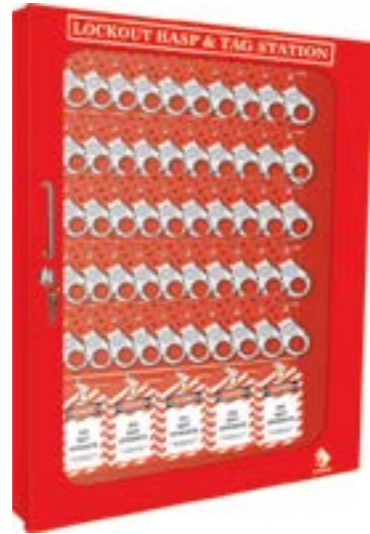

RSG - H+T C 50 WG

MODEL	PRODUCT DESCRIPTION	Size in inch (H x W x D)
RSG - H+T C 50	Hasp & Tag Cabinet (50 + 50)	36 x 22 x 2
RSG - H+T C 50WG	RSG - H+T C 50 with Goods	36 x 22 x 2



**CUSTOMIZED
KEY BOX**

- Metal Wall Key Box
- Made of powder coated metal sheets.
- These boxes accommodates 1 or 3 keys.



RSG - LEKB

RSG - GLKB 3R

MODEL	PRODUCT DESCRIPTION	Size in inch (H x W x D)
RSG - LEKB	Lockout Emergency Key Box for 1 Key	6 x 5 x 1.75
RSG - GLKB 3R	Group Lockout Key Box - Red for 3 Key	8.25 x 6.5 x 1.75



Simplifies lockout of large equipments and helps ensure maximum security for complex work team situations. After machine or process is locked out, the key or keys of the machines are placed in a lock box. Each authorised work team member places a personal lock on the group lock box. Ensures that no single employee has access to the box unless all employees have removed their locks.

GROUP LOCK BOXES

GROUP LOCK BOX

- Made of special grade Metallic Sheet.
- Duly Powder Coated and supplied with multiple slots in the box body and its flap for holding lockout padlocks. Used for Group lockouts.
- Besides in the slots - extra padlock can be installed on the locking buckle.
- For easy handling and carrying - an ergonomic Stainless Steel handle is provided on the top side.
- Normally, each box is powder coated Red - other colours like Yellow / Blue / Green etc. can be supplied as per customer's requirement. *Minimum Quantity Required.
- Wall bracket group lock boxes are also available for fixed installation.
- Stainless Steel group lockout box with clear Polycarbonate sheet are available for corrosive areas.
- Lockout message is normally printed in English. Other Regional Language / Company Logo /Dept . Name can also be incorporated on request.
- Each piece is individually packed in white corrugated box.
- Master carton contains 10 pieces.



RSG - GLB - R 7



RSG - LB - Y



RSG - GLB - R 13



RSG - GLB - R 17



RSG - GLB - WB



RSG - GLB - SS



* minimum quantity 100 Nos.



MODEL	PRODUCT DESCRIPTION	Size in inch (H x W x D)
RSG - GLB - R 7	Group Lock Box - Red 7	7.35 x 4.85 x 4.35
RSG - LB - Y	Lockout Box - Yellow	7.25 x 10.75 x 4.35
RSG - GLB - R 13	Group Lock Box - Red 13	7.25 x 10.75 x 4.35
RSG - GLB - R 17	Group Lock Box - Red 17	7.25 x 10.75 x 4.35
RSG - GLB - WB	Group Lock Box with Wall Bracket	7.25 x 10.75 x 4.35
RSG - GLB - SS	Group Lock Box - Stainless Steel	7.25 x 10.75 x 4.35

GROUP LOCK BOXES

GROUP LOCK BOX

- Bigger size group lock boxes are made to carry the critical parts of machinery along with the keys /fuses, etc.
- They are available with sliding clear fascia also.
- RSG - GLB - C 17 is combination of box and clear GLB.
- Wall mounting RSG - GLB - ST 15 has key hangers inside.
- Customized group lock box store cabinets are made as per customer's requirement in different sizes to accommodate the selected type of GLB's.



RSG - GLB - B 4



RSG - GLB - L 13



RSG - GLB - SL 26



RSG - GLB - C 17



RSG - GLB - ST 15

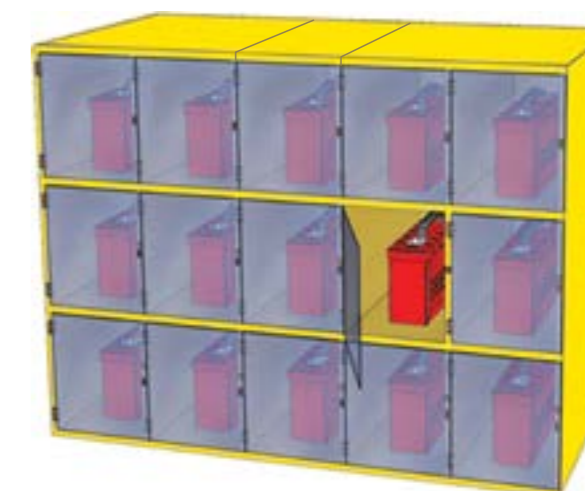

RSG - C GLB

* minimum quantity 100 Nos.



MODEL	PRODUCT DESCRIPTION	Size in inch (H x W x D)
RSG - GLB - B 4	Group Lock Box - Big 4	8.25 x 12.35 x 7.75
RSG - GLB - L 13	Group Lock Box - Large 13	7.10 x 10 x 7.30
RSG - GLB - SL 26	Group Lock Box - Slider 26	4.25 x 9.25 x 5.50
RSG - GLB - C 17	Group Lock Box - Combo 17	7.10 x 13.60 x 7.75
RSG - GLB - ST 15	Group Lock Box - Standing 15	11.35 x 6.25 x 3.35
RSG - C GLB	Cabinet for Group Lock Box	30 x 60 x 12 (For 15)

GROUP LOCK BOXES

GROUP LOCK BOX: WALLMOUNT / EASY CARRY

- Efficient way for a group of employees to lockout equipment that has multiple lockout points.
- Wall mount group lock boxes create a central location for group lockouts throughout your facility.
- Durable steel with clear polycarbonate window allows supervisors to double check that the key for each lockout point is enclosed.
- Keyhole slot makes it easy to add keys to the box after it has been locked out.
- Keys are not accessible until every lock is removed and panel slides open.
- Pre-drilled holes and hardware included.
- Provides easy access for employees and is highly visible.
- Choose from three styles.



RSG - WGLB - US 7

RSG - WGLB - US 9

RSG - WGLB - US 12



RSG - WGLB - T



RSG - WGLB - SS Y

MODEL	PRODUCT DESCRIPTION	Size in inch (H x W x D)
RSG - WGLB - US 7	Wallmount Group Lock Box - Upper Slider 7	9.25 x 8.10 x 2.35
RSG - WGLB - US 9	Wallmount Group Lock Box - Upper Slider 9	13.35 x 12 x 3.10
RSG - WGLB - US 12	Wallmount Group Lock Box - Upper Slider 12	9.35 x 17 x 2.35
RSG - WGLB - T	Wallmount Group Lock Box - Twin	7 x 12 x 2
RSG - WGLB - SS Y	Wallmount Group Lock Box - Side Slider Yellow	6.5 x 14.25 x 6



GROUP LOCK BOXES

KEY GROUP LOCKOUT BOX

- These boxes and hooks are made of powder coated special grade steel sheets for maximum durability.
- Stainless Steel handle is provided on the top for easy carrying.
- Pre-drilled holes and hardware is available for mounting on the wall.
- Transparent window for clear visibility of keys and documents.
- Comes with durable red and white powder coated finish.
- Document holder slots are provided on the main body of this GLB for carrying company's lockout/tagout forms or permits.



RSG - GL - 1/2



RSG - GL - 1

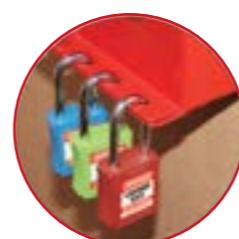

RSG - GL - 2



RSG - GL - 3

MODEL	PRODUCT DESCRIPTION	Size in inch (H x W x D)
RSG - GL - 1/2	4 - Key Group Lockout Box	11.25 x 6 x 3.10
RSG - GL - 1	8 - Key Group Lockout Box	12.25 x 12 x 3.10
RSG - GL - 2	24 - Key Group Lockout Box	18.75 x 12.50 x 3.10
RSG - GL - 3	50 - Key Group Lockout Box	21.25 x 18 x 3.10



GROUP LOCK BOXES

WALLMOUNT / STORAGE GROUP LOCK BOX



- Wallmount storage / group lock boxes provide one central location to store all lockout devices - department wise.
- Lockable steel cabinet reduces theft & keeps loto supplies secure.
- Group lockout is very easy to use in any facility, increasing safety as well as communication.
- Label on inside door serves as a handy reference by providing 10 basic steps for lockout.
- These units can be order duly filled with lockout devices or unfilled to be used with your own supplies.
- Available in small, medium and large sizes to fulfill your lockout needs.
- Ideal for large groups or a facility that needs to lock out many equipments.
- Clear window lets you see which keys are locked out.
- Keyhole slot allows keys to be inserted after box has been secured.
- After last lock is removed, panel opens to access keys in box.
- Lock box on RSG - WPR - GLB holds up to 7 padlocks.
- Pre-drilled holes and hardware is available for mounting on the wall.



RSG - WPR - GLB



RSG - WS GLB - S



RSG - WS GLB - M



RSG - WS GLB - L

MODEL	PRODUCT DESCRIPTION	Size in inch (H x W x D)
RSG - WPR - GLB	Wallmount Padlock Rack with Group Lock Box - Small	19 x 7 x 2
RSG - WS GLB - S	Wallmount Storage with Group Lock Box - Small	21.5 x 10.25 x 4.25
RSG - WS GLB - M	Wallmount Storage with Group Lock Box - Medium	25 x 15.5 x 4.25
RSG - WS GLB - L	Wallmount Storage with Group Lock Box - Large	25 x 31 x 4.25



GROUP LOCK BOXES

27- HOLE GROUP LOCK BOX

Manufactured from high quality ABS. Once a single padlock is placed on the central lock point, the inner contents cannot be tampered with. A slot in the cover allows additional lockout keys to be dropped in without exposing the existing contents after shutdown has begun.

- deal for Group Lockout Procedures.
- Has 16 internal hangers for keys.
- 27 holes are provided for installing Lockout Pad locks. (Sold Separately)
- Clear tamper-proof top sliding or hinged cover options are available.
- Transparent cover allows to identify keys inside.



RSG - GLB - H 27

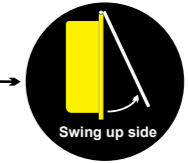

RSG - GLB - TS 27

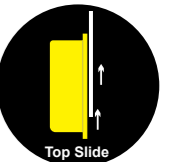

MODEL	PRODUCT DESCRIPTION	Size in inch (H x W x D)
RSG - GLB - H 27	Group Lock Box - Hinged Fascia Panel	11 x 13 x 4
RSG - GLB - TS 27	Group Lock Box - Top Sliding Fascia Panel	11 x 13 x 3.4



GROUP LOCK KEY CABINET

Safety lockout boxes are ideal for group lockout situations. After the equipment to be worked on has been locked off, all lockout keys are placed inside the lockout box and locked by the responsible person. Each worker then retains its key ensuring access cannot be gained to the keys kept inside the box.

They can be made as per customer's requirement in different sizes and with different number of locks on the cover.



RSG - GLKC

MODEL	PRODUCT DESCRIPTION	Size in inch (H x W x D)
RSG - GLKC	Group Lock Key Cabinet	18.25 x 15.5 x 2





GROUP
LOCK MINI BOXES

Powder Coated Customized Lockout Key / Document Holder Boxes are made of steel with polycarbonate unbreakable clear fascia and padlock eye / slot for Holding LOTO Hasp and Locks.

Other sizes are made on request with or without the clear fascia in Red, Yellow or other colour powder coating.

They can be arranged in different numbers / rows / columns, etc. as per site / lockout procedure requirement of different companies (As shown on the next page).



RSG - GLMB - 1

RSG - GLMB - 2

RSG - GLMB - 3

RSG - GLMB - 4

MODEL	PRODUCT DESCRIPTION	Size in inch (H x W x D)
RSG - GLMB - 1	Group Lock Mini Box - 1	6.25 x 6.25 x 2.10
RSG - GLMB - 2	Group Lock Mini Box - 2	6.25 x 6.25 x 2.10
RSG - GLMB - 3	Group Lock Mini Box - 3	6.25 x 6.25 x 2.10
RSG - GLMB - 4	Group Lock Mini Box - 4	6.25 x 6.25 x 2.10



WALL MOUNTED
STATION FOR
GROUP LOCK
MINI BOXES

- They are created as per customer requirements in different combinations with written instructions.
- Customization like department name, box no., colour of the box or the background plate, printing of logo, etc. can be done and supplied according to the purchase order.
- These station can be made and supplied as wall mounted or on revolving wheels as per the site requirements.
- RSG - GLMB - 1, 2, 3, 4 can be selected for required stations.
- *GLMB can be made from the size 4"x4" to any size /specifications like with or without internal shelves, with clear fascia or steel mesh fascia, with or without keyhole option on the doors.

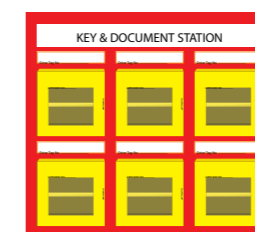

RSG - WMS GLMB 6

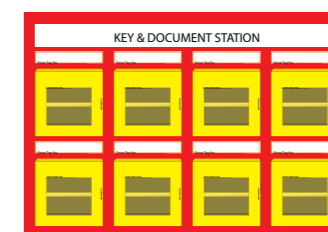

RSG - WMS GLMB 8

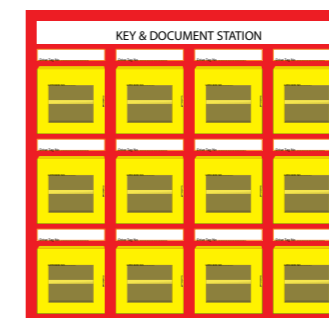

RSG - WMS GLMB 12

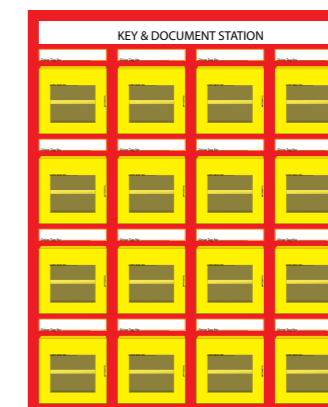

RSG - WMS GLMB 16

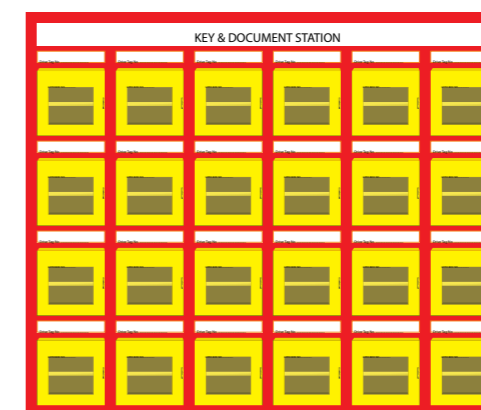

RSG - WMS GLMB 24



RSG - PS GLMBW

MODEL	PRODUCT DESCRIPTION
RSG - WMS GLMB 6	Wall Mounted Station for GLMB - 6 Box
RSG - WMS GLMB 8	Wall Mounted Station for GLMB - 8 Box
RSG - WMS GLMB 12	Wall Mounted Station for GLMB - 12 Box
RSG - WMS GLMB 16	Wall Mounted Station for GLMB - 16 Box
RSG - WMS GLMB 24	Wall Mounted Station for GLMB - 24 Box
RSG - PS GLMBW	Portable Station for GLMB on Wheel



SAFETY LOCKOUT BOXES

Safety lockout boxes are ideal for group lockout situations. After the equipment to be worked on has been locked off, all lockout keys / fuses etc. are placed inside the lockout box and locked by the authorised person.

In the RSG - SLB - 5L & 8L model each worker puts his own padlock and retains its key, ensuring access cannot be gained to the keys / fuses etc. kept inside the box - until the work is completed. Only when all locks are opened the lockout keys and fuses can be accessed.

Locks can be procured separately as per requirement.

RSG - SLB - 3K, 4K, 5K & 8K model are supplied with inbuilt cabinet locks which can not be removed from their slots.

- Control keys can be "key alike" for multiple boxes under the control of the responsible person (Control Key).
- All secondary keys are "key different".
- Keys can be provided with individual identification key chains.
- All the boxes have A, B, C,..... or 1,2,3,..... marking for individual locks, which can be customized as per customer's requirement. The keys black portion also have the same numbering / marking as given on the boxes.

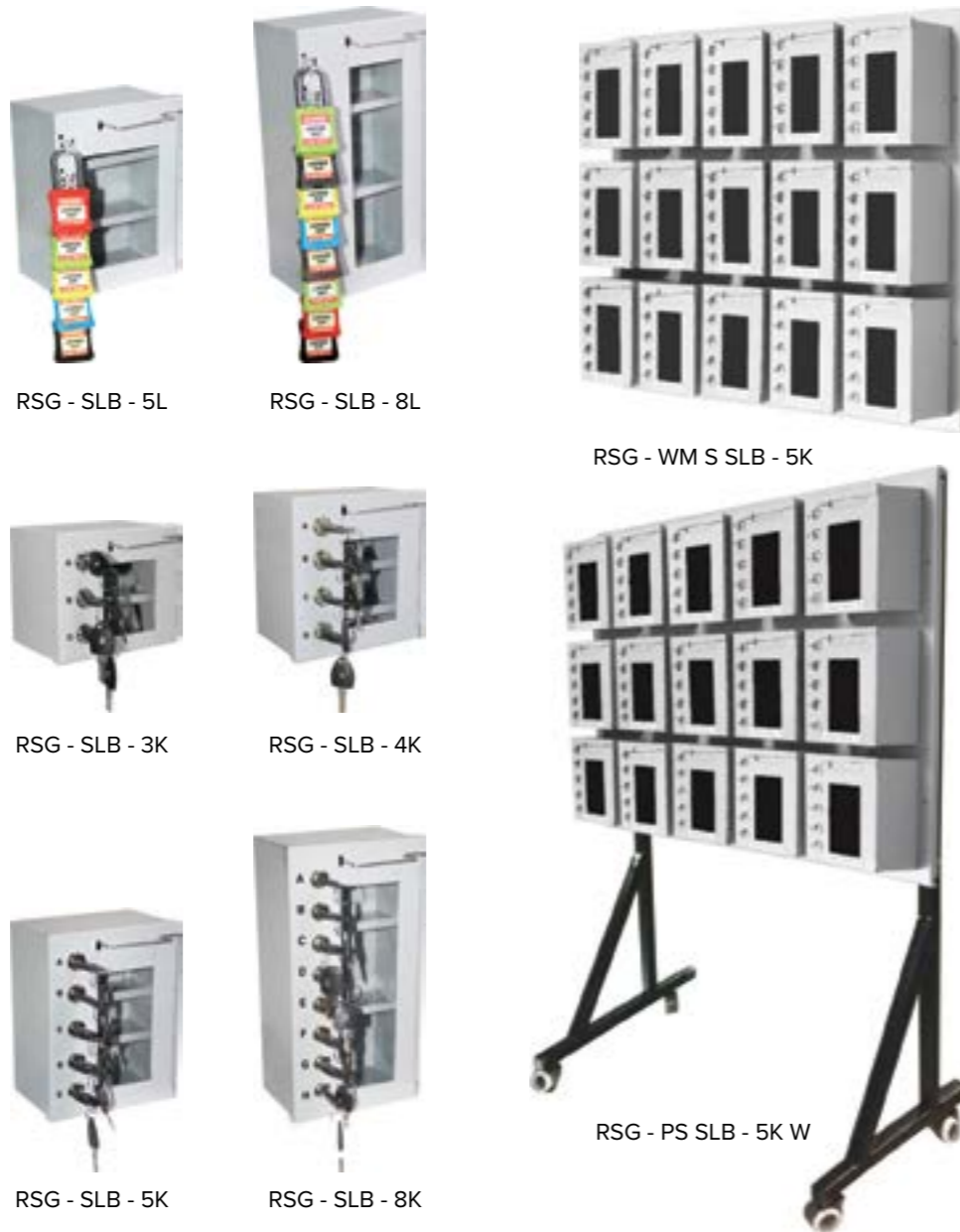

MODEL	PRODUCT DESCRIPTION	Size in inch (H x W x D)
RSG - SLB - 5L	Safety Lockout Box with 5 Locks	8 x 6.25 x 4.15
RSG - SLB - 8L	Safety Lockout Box with 8 Locks	12.25 x 6.25 x 4.15
RSG - SLB - 3K	Safety Lockout Box with 3 Keys	5 x 6.25 x 4.15
RSG - SLB - 4K	Safety Lockout Box with 4 Keys	6.5 x 6.25 x 4.15
RSG - SLB - 5K	Safety Lockout Box with 5 Keys	8 x 6.25 x 4.15
RSG - SLB - 8K	Safety Lockout Box with 8 Keys	12.25 x 6.25 x 4.15
RSG - WM S SLB - 5K	Wall Mounted Station for RSG - SLB - 5K	Customized
RSG - PS SLB - 5K W	Portable Station for RSG - SLB - 5K on Wheels	
RSG - SLB - 1K 12H R	Safety Lockout Box with 1 Keys - 12 Holes - Red	6 x 6 x 2.5
RSG - SLB - 5K 12H	Safety Lockout Box with 5 Keys - 12 Holes	9 x 6 x 3.5



- Highly visible safety tags aid the safe running and maintenance of site machinery. Each Tag is manufactured from high impact flexible polyvinyl sheets - resistant to water, oil and extreme temperatures, ensuring it will withstand a multitude of weather and factory conditions / harshest environments.
- Their surface allows you to write on them easily with a marker pen.
- All the Tags can be attached with a Saf-T-Lock devices directly or they can be attached with the help of a Nylon Tie.
- Individual workers use the DANGER TAG while working on the equipments.
- Accident Prevention Tags are used to inform people of probable danger around particular machine or an area and to provide the safety instructions.

STANDARD SAFETY LOCKOUT TAGS

- These highly visible safety tags aid the safe running and maintenance of site machinery. Each Tag is manufactured from high impact styrene / flexible polyester -resistant to water, oil and extreme temperatures, ensuring it will withstand a multitude of weather and factory conditions / harshest environments.
- Their surface allows you to write on them easily with a marker pen. • •
- Semi-rigid plastic Tags of 0.5 / 0.7 mm thickness.
- All the Tags can be attached with a Saf-T-Lock device directly or they can be attached with the help of a Nylon Tie.
- Individual workers use the DANGER TAG while working on the equipments.
- Accident Prevention Tags are used to inform people of probable danger around particular machine or an area or to provide the safety instructions.
- Our quality 0.7 mm tags are tear proof.
- Available in pack 10 / 25 / 50 / 100.



Common Back Side (T1 to T6 & T8 to T24)

MODEL	PRODUCT DESCRIPTION	Size in mm (h x w)
RSG - TAGS	Tags Made of white special grade PVC sheet	145 X 80

TAG CUSTOMIZATION

- All kinds of TAGS can be made as per client's requirement on 0.5 / 0.7 mm white PVC sheets in any Colour, Text, Graphic, Company Logo, Department Name, Language, etc.
- Minimum Quantity : 200 Nos. (Each Graphic) for screen printing and 10,000 pieces for the offset printing on hard paper.
- Bi-lingual tags are also made against order.



Examples:



CUSTOMIZED LOCKOUT TAGS

- All kinds of TAGS can be made as per client's requirement on 0.5 / 0.7 mm white PVC sheets in any Colour, Text, Graphic, Company Logo, Department Name, Language, etc.
- Minimum Quantity : 200 Nos. (Each Graphic) for screen printing and 10,000 pieces for the offset printing on hard paper.
- Bi-lingual tags are also made against order.



CUSTOMIZED LOCKOUT TAGS



SELF LAMINATING / LINER PROTECTIVE TAGS

- Self-laminating tags have become a mainstay for environmentally hostile conditions. When you need a customized message that won't smudge or wear, use our self-laminating tags that let you seal in your message under a clear, protected layer.
- Each tag features a reinforced eyelet for sturdy hanging with a wire or nylon tie. Simply remove the lining and press the clear polyester layer onto your text to laminate.
- Write on this tag with any marker pen for a smudge-free message.
- Durable tags will resist water and wear in your facility.
- These tags are made of 0.7 mm white special grade PVC sheet with polyester over laminate to protect the photo and other written data.



RSG - TAG+L



LOCKOUT ECONOMY TAGS

- Made of hard paper and laminated after printing.
- Easy to write on and stays legible longer.
- Brass eyelet accepts most padlock shackles.
- Standard packing of 100 tags.



RSG - LE TAGS



MODEL	PRODUCT DESCRIPTION	Size in mm (h x w)
RSG - LE TAGS	Lockout Economy Tags (set of 100 nos.)	145 X 80

LOCKOUT TAGS ON ROLL (BOX)

- Get convenience, storage and simplicity - all in a tag dispenser, where tags are joined at perforated edges and one can separate them neatly.
- Convenient, Tough and Economical! Just "Pull" and "Tear" off a durable lockout tag from this handy roll. A box makes it easy to keep your tags handy and neat.
- Each tag is 145 x 80 mm.
- Tag is made of flexible plastic that is both tear-proof and waterproof.
- Tags can be used inside or outdoors.
- There are 100 tags in each box.



RSG - TOR



MODEL	PRODUCT DESCRIPTION	
RSG - TOR	Lockout Tags on Roll (BO)	* Minimum 20 Rolls

LOCKOUT TAGS: PERFORATED

- Tag features perforated section that can be torn off. Numbered tags are made of hard card -laminated.
- Two-part tags provide enhanced operational control and record-keeping. Stub is removed when tag is attached to a lockout point. Only the employee in possession of the stub has the authority to remove the tag.
- After the job is done, stub is returned to management for verification and monitoring of lockout and tagout activity in the plant.



A

B



Rings can be ordered separately

Tags can be sequentially numbered

off perforated

Brass eyelet



MODEL	PRODUCT DESCRIPTION	Size in mm (h x w)
RSG - TAG + 1	Tags with perforation	175 X 80

LOCKOUT SQUARE TAGS

These square tags are printed both sides with customised notice. Your employee name and date of working can be written, which indicates, who is working on the isolated equipment.



Common Back Side

MODEL	PRODUCT DESCRIPTION	Size in mm (h x w)
RSG - LS TAGS	Lockout Square Tags (set of 50 Nos.)	100 x 100



REINFORCED TAGS

These single side printed 0.7 mm PVC tags gives a clear caution message. Ideal for use through lock shackles, they have a reinforced brass eyelet preventing the tag from tearing. **Set of 10 Nos.**



RSG - RCT

PERSONALISED TAGS

These personalised laminated ID tags are printed both sides with customised notice. Your employee name and photograph are added, which clearly shows - who is working on the isolated equipment. **Set of 10 Nos.**



RSG - PD TAGS



MODEL	PRODUCT DESCRIPTION	Size in mm (h x w)
RSG - RCT	Reinforced Caution Tags	75 x 100

MODEL	PRODUCT DESCRIPTION	Size in mm (h x w)
RSG - PD TAGS	Personalised Tags	120 x 75

DISPOSABLE LOCKOUT TAGS



These disposable lockout tags are manufactured from hard paper. Ideal for short term indoor or outdoor isolations. Printed on both sides, each tag carries a standard "Danger this equipment has been locked out, Do not operate" message with a choice of 7 different reverse messages or blanks to suit various applications. **Supplied in pack of 100 (Straight cut).**



Common front side for (RSG - DL TAGS 1 to 7)

MODEL	PRODUCT DESCRIPTION	Size in mm (h x w)
RSG - DL TAGS	Disposable Lockout Tags	145 X 80



DISPOSABLE LOCKOUT TAGS



- Clearly identifies who is in-charge of the lockout procedures.
- 0.7 mm Self-laminating tags allow employees to fill in vital information.
- Add a small size personal photo and seal it under the attached clear self-adhesive overlay.
- Will resist chemicals, abrasion, grease and solvents.
- **Supplied in pack of 10 Nos.**



MODEL	PRODUCT DESCRIPTION	Size in mm (h x w)
RSG - PI TAGS	Photo Id Lockout Tags - Yellow	145 X 80



**LOCKOUT
PADLOCK TAGS**

- Slips easily over padlock shackles, padlock tags hang flat on padlock for quick identification ensuring that the status is noticed at a glance.
- These padlock tags are manufactured from 0.7 mm PVC sheet & they accept marker for writing.
- They are made as per customer's requirement with or without metal grommet that fits over most padlock shackles.



RSG - LPT 1



RSG - LPT 2



RSG - LPT 3



RSG - LPT 3 C



RSG - LPT 4



LPT 4 A

LPT 4 B

LPT 4 C

LPT 4 D

LPT 4 E



LPT 4 F

LPT 4 G

LPT 4 H

LPT 4 I

LPT 4 J

MODEL	PRODUCT DESCRIPTION	Size in mm (h x w)
RSG - LPT 1	Lockout Padlock Tags - 1	145 x 80
RSG - LPT 2	Lockout Padlock Tags - 2	175 x 50
RSG - LPT 3	Lockout Padlock Tags - 3	105 x 40
RSG - LPT 3 C	Lockout Padlock Tags - 3 Color	105 x 40
RSG - LPT 4	Lockout Padlock Tags - 4	125 x 50



**TAG
HOLDER / STATION**

- Keep your lockout / tagout tags clean and organized with our Tag Holder / Station.
- Store your tags right where they are needed.
- RSG - TH 20 is designed to hold 20 Nos. Tags. Tag holder comes with screws & sleeves for mounting.
- RSG - TS designed to hold maximum size of 145 mm x 80 mm tag, our tag station has 8 clear acrylic pockets for holding tags.
- Customized Tag Station can be made against order for any number of tag holder pockets.
- RSG - YB SLTS shadow tag station can be designed and supplied for various departments in a plant with company logo and other relevant information as desired / indicated in the company's lockout policy.



RSG - TH 20



RSG - TS



RSG -YB SLTS - 8



RSG -YB SLTS - 16

MODEL	PRODUCT DESCRIPTION	Size in mm (h x w)
RSG - TH 20	Lockout Tag Holder	9 x 5
RSG - TS	Lockout Tag Station	18.5 x 17.5
RSG - YB SLTS - 8	Yellow & Black Shadow Lockout Tag Station - 8	34 x 12
RSG - YB SLTS - 16	Yellow & Black Shadow Lockout Tag Station - 16	34 x 21



LOCKOUT TAG ACCESSORIES

LOCKOUT PADLOCK TAGS

- Available in pack of 50 or 100 nos.
- Size of these padlock tags is 1" x 5" (25 mm x 125 mm).
- Special construction in 0.5 mm superior grade PVC material for a greater resistance than paper to tear, chemical & humidity.
- Tags with "Danger - Do not Operate" message can be customized as per customer requirement to include name of site with date, employee name and remarks, etc.
- Can be supply in different colours for different departments.



RSG - DLPT C



RSG - DLPT SS



RSG - DLPT DS

MODEL	PRODUCT DESCRIPTION
RSG - DLPT SS	Disposable Lockout Padlock Tags - Single Side
RSG - DLPT DS	Disposable Lockout Padlock Tags - Double Side
RSG - DLPT C	Disposable Lockout Padlock Tags - Colour



CABLE TIE FOR LOCKOUT TAGS

- Enables secure attachment of visual tagging system to equipment.
- Cable ties are made with a one piece construction to provide consistent performance and reliability.
- Available in 6" and 8" size.
- Available in set of 10 / 25 / 50 / 100 nos.

RSG - TIES 6

MODEL	PRODUCT DESCRIPTION
RSG - TIES 6	Nylon Ties for Tags - 6 inch
RSG - TIES 8	Nylon Ties for Tags - 8 inch



RSG - TIES 8

PEN FOR TAGS

- These special Waterproof, Lightfast, Multimark Pens are supplied for writing on the Tags. They contain eraser on the other end of the pen.
- Available in Black / Blue / Green & Red colours.



RSG - PEN

MODEL	PRODUCT DESCRIPTION
RSG - PEN	Lockout Pen for Tags



ENERGY SOURCE IDENTIFICATION TAGS



With Energy Source Identification Tags, one can clearly identify the name and source of the energy source to be locked out.

**ENERGY SOURCE
IDENTIFICATION
TAGS: MICRO**

Energy sources carry a number of risks that affect workers who service machines and equipment. Assist workers in understanding hazardous energy sources by tagging them. These single sided printed Energy Source Identification Micro Tag helps identify different Control sources.

- These PVC 0.7 mm thick tags are tear-proof, weather-resistant, chemical-resistant and durable enough to withstand dirt, grease, liquid-splashes, repeated abuse, or rough handling.
- Order individual numbers as per requirement, or purchase a kit which includes numbers 1-10.
- Customized numbers can be ordered in the set of 10 nos.



* minium order quantity applicable
Ask for special prices
for complete project



MODEL	PRODUCT DESCRIPTION	Size in mm (h x w)
RSG - ESIDT M	Energy Source Identification Tags - Micro	75 x 50

**ENERGY SOURCE
IDENTIFICATION
TAGS: SHAPED**

- Vibrant colours, bold graphics and unique shapes that can be easily and quickly identified are ideal for machine specific procedures.
- 3 mm PVC Tags comes with 4 mm hole. Size : 75 x 75 mm
- Also available in self adhesive tags with choice of different numbers - for directly fixing on the machines.

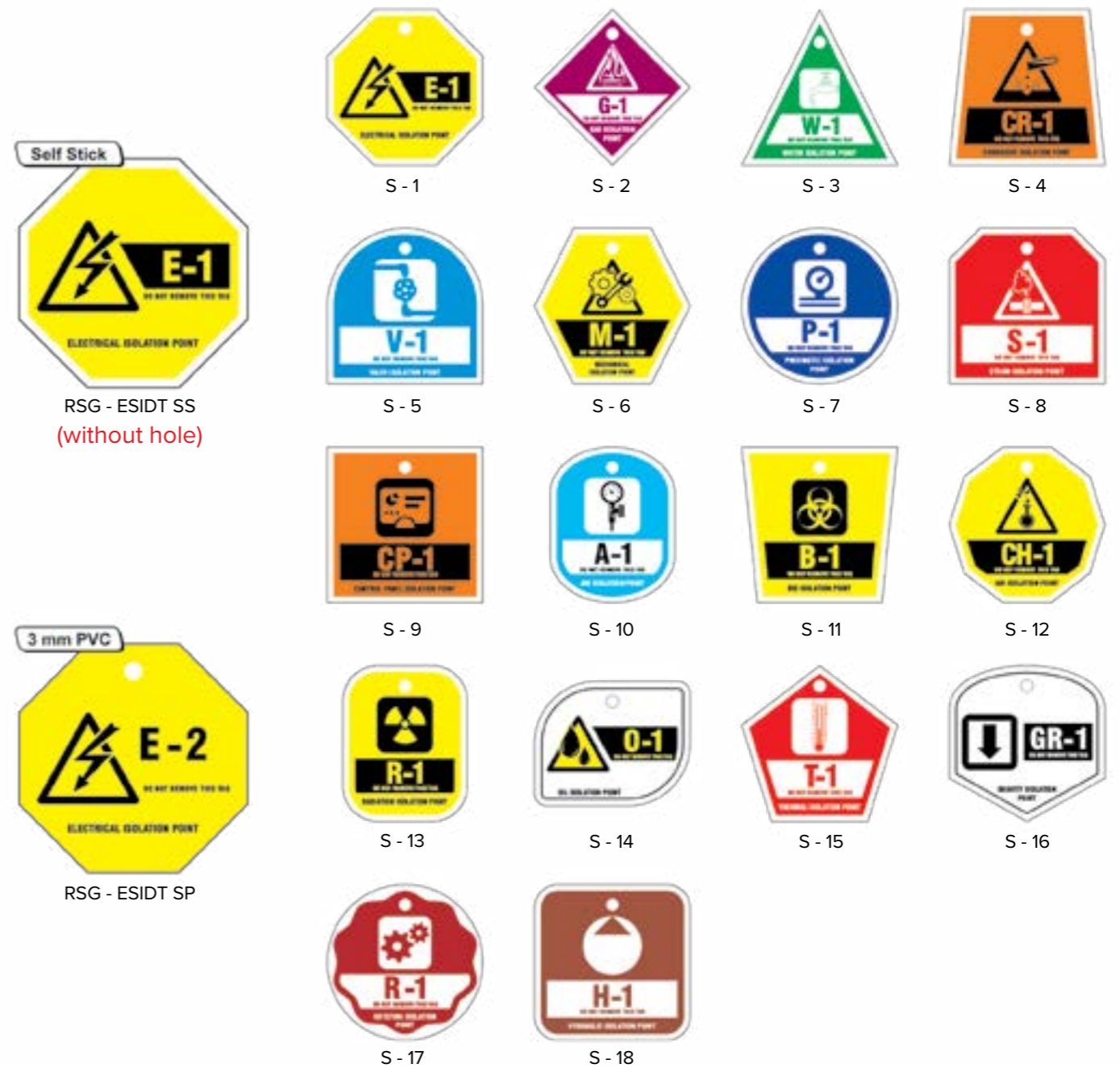

* minium order quantity applicable
Ask for special prices
for complete project



MODEL	PRODUCT DESCRIPTION
RSG - ESIDT SS	Energy Source Identification Tags - Shaped Self-stick
RSG - ESIDT SP	Energy Source Identification Tags - Shaped PVC

Design approval on
receipt of order

ENERGY SOURCE IDENTIFICATION TAGS

ENERGY SOURCE IDENTIFICATION TAGS: PREMIER

- These premier ID Tags are available in vibrant colours with bold graphics, duly placed in the clear PVC casing with SS ring.
- Tag Size : 57 x 100 mm
- Case Size : 60 x 130 mm
- These self adhesive tags are available without casing also, with the choice of different numbers as per customer's LOTO procedure requirement for directly fixing on the machines.



RSG - ESIDT P



RSG - ESIDT P + C



MODEL	PRODUCT DESCRIPTION	Size in mm (h x w)
RSG - ESIDT P	Energy Source Identification Tags - Premier self stick	57 x 100
RSG - ESIDT P + C	Energy Source Identification Tags - Premier with Case	60 x 130

LOCKOUT SIGNS & LABELS



Keep your workers and visitors safe in your facility with Lockout Signs. Identify energy control points that require lockout and send a clear warning that will help keep workers aware of any potential hazards near equipment, machinery and electricity. Lockout signs are not only a great way to keep your workplace safe, but a great means of keeping productivity up through the visual identification of lockout areas. Lockout signs are available in a wide range with CAUTION and WARNING formats, sign sizes and styles also differ from each other - more than 200 signs to choose from. Customized signs are made as per the requirement of machines / plant areas.



LOCKOUT SIGNS



- Lockout Signs are available in self-stick formats.
- Some of the signs are shown here under for easy selection and ordering.
- Customized signs in different languages, formats, sizes, captions, message, etc can be made and supplied as per the requirements of LOTO policy and procedures of individual companies.



MODEL	PRODUCT DESCRIPTION	Size in mm (h x w)
RSG - LS	Lockout Safety Signs	6 x 8 / 8 x 10

Signs can be customized by using these lockout icons.



LARGE LOCKOUT WALL SIGNS



These large safety lockout wall signs can be supplied in either self adhesive vinyl or on rigid PVC. They act as a constant reminder to lockout before commencing service or maintenance. Size: 18" x 24"

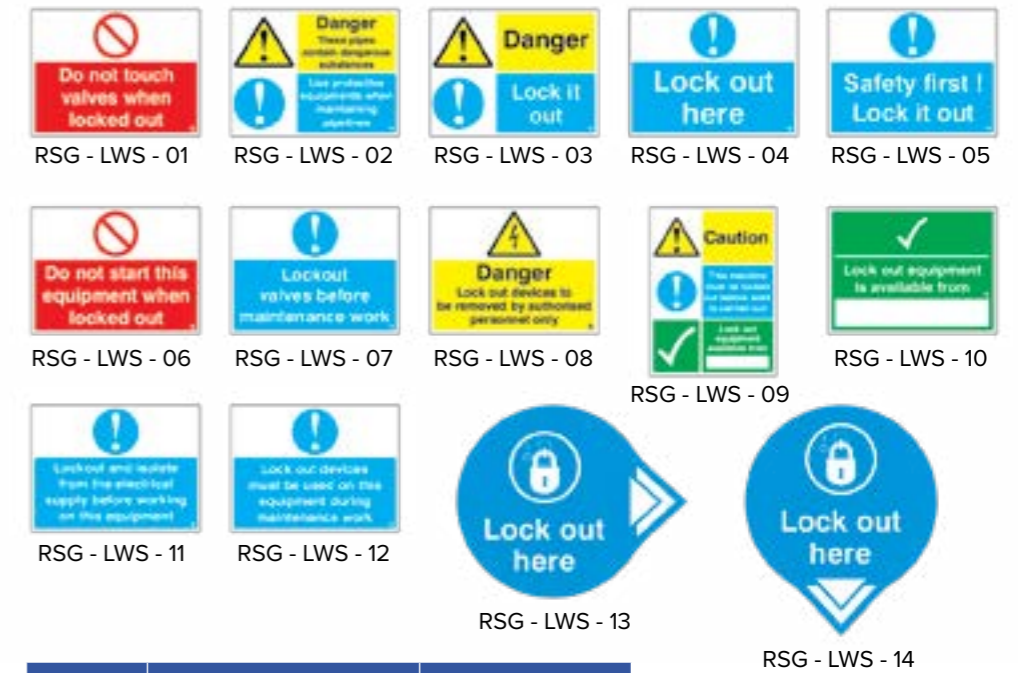

MODEL	PRODUCT DESCRIPTION	Size in mm (h x w)
RSG - LWS	Large Lockout Wall Signs	450 x 600



HANGING LOCKOUT SIGNS

Use the soft nylon cord to hang these signs from machinery during lockout procedures. Material: 3 mm PVC sheet. Size: 18" x 24" / 8" x 6" / 6" x 9"

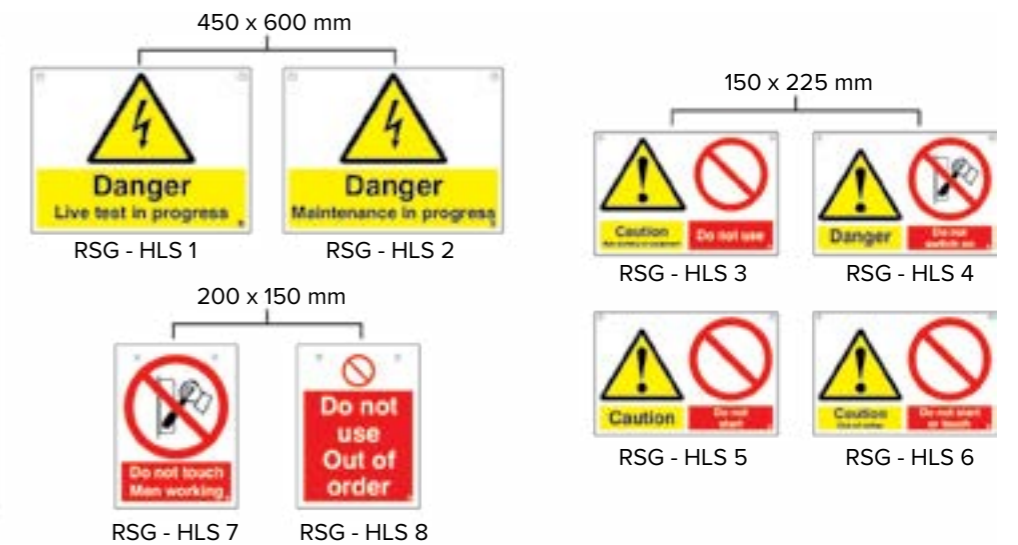

MODEL	PRODUCT DESCRIPTION
RSG - HLS	Hanging Lockout Signs

* Contact us for more signs in Different Sizes / Languages / Material (Rigid / Flexible / Selfstick / Photoluminescent / reflective etc.).



LOCKOUT SIGNS & LABELS

SAFETY LOCKOUT LABELS



This range of labels are ideal for use on electrical equipment where a safety message needs to be conveyed. Manufactured from self adhesive vinyl. Sold in pack of 10. Size: 2" x 3"



MODEL	PRODUCT DESCRIPTION	Size in mm (h x w)
RSG - S LABEL	Safety Lockout Label	50 x 75



MAGNETIC SIGNS



RSG - MCS

Magnetic signs are ideal for quick and easy attachment next to lockout points giving a clear caution message that equipment has been locked out.

All the sign shown in this catalogue can be made as magnetic sign on request.



MODEL	PRODUCT DESCRIPTION	Size in mm (h x w)
RSG - MCS	Magnetic Caution Signs	100 x 200
RSG - MS C	Magnetic Signs - Customized	50 X 100



SAFETY LOCKOUT ARROW MARKERS



- They are normally stuck on the electrical panels / machines / pipe lines, etc. to highlight the location of the switches / valves / sockets, etc. where the lockout gadgets are to be installed.
- Detachable arrows are used to show the exact direction and spot for the warning.
- Vinyl labels are durable and stick to most every surface.



MODEL	PRODUCT DESCRIPTION
RSG - SLAM	Safety Lockout Arrow Markers



LOCKOUT SIGNS & LABELS

LOCKOUT BEFORE STARTING MARKING LABELS

- These Lockout - Before Starting Work Labels are required for the safe maintenance and operation of working machinery, plant and equipment.
- These Lockout Before Starting Work Labels are highly visible and should be placed properly, so that any person who is responsible for operating machinery, plant and equipment can see them clearly.
- They are to be placed on clean, flat and smooth surface.



LBSML 19



MODEL	PRODUCT DESCRIPTION	Size in mm (h x w)
RSG - LBSML	Lockout Before Starting Marking Labels	2 x 2

SAFETY LOCKOUT HARD HAT LABELS

- Durable self adhesive vinyl labels.
- These labels are enough for hard hats, helmets, equipment and more.
- Choose from a variety of bold brightly coloured labels.



Show certified Lockout Tagout trained employees with a hard hat labels that stands out. With unique die-cut shapes that easily conform to any hard hat, these bold, easy-to-see messages can help you identify trained staff in seconds. Make everyone know who your authorized employees are for lockout tagout procedures. "LOCK-OUT TAG-OUT TRAINED" (Select Year) Hard hat labels help prevent injury to employees who are servicing machines and equipment.



MODEL	PRODUCT DESCRIPTION	Size in mm (h x w)
RSG - HHL - C	Safety Lockout Hard Hat Label - Circular	2 x 2
RSG - HHL - T	Safety Lockout Hard Hat Label - Triangular	2.5 x 2.5

